

# PRÉCISION & QUALITÉ

## LEADER DANS L'INDUSTRIE



**MARCHE-PIED EN ALUMINIUM  
ET BIEN PLUS** 1-855-835-2422  
[www.6sserden.com](http://www.6sserden.com)

MARCHE-PIED  
1 MARCHE

30-22004

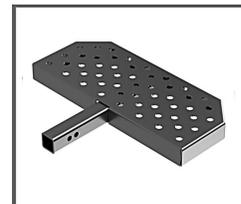
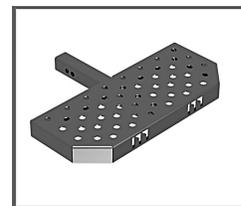
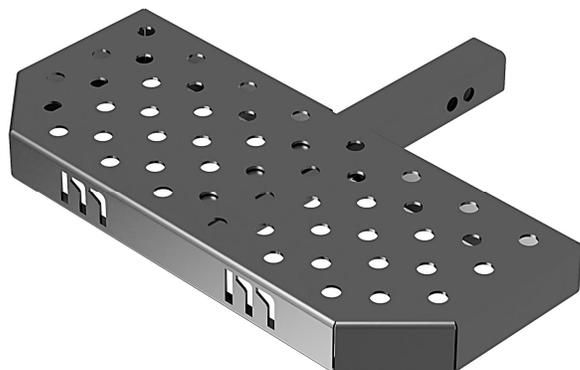

## MARCHE-PIED 1 MARCHE 10" x 24"

- Marche-pied en aluminium
- Longueur 24"
- Largeur 10"
- Poids: 7 Lbs
- Facilite l'accès de votre boîte en toute sécurité

MARCHE-PIED  
1 MARCHE

30-22005

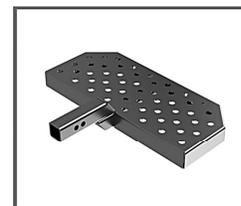
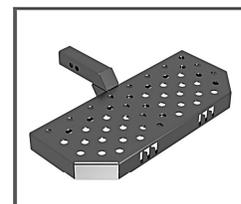
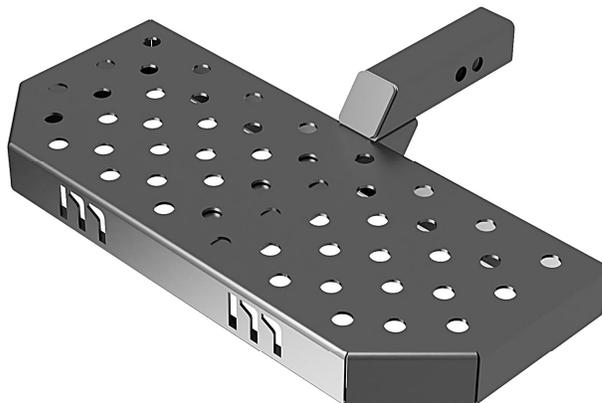

## MARCHE-PIED 1 MARCHE 10" x 24" (-2")

- Marche-pied en aluminium
- Poids: 7 Lbs
- Longueur 24"
- Largeur 10"
- (-2") sous le niveau de l'attelage du véhicule

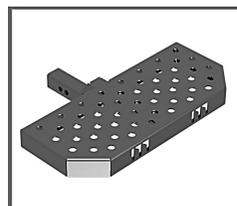
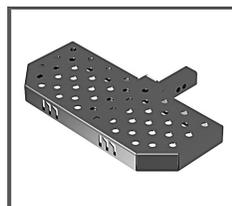
**MARCHE-PIED  
1 MARCHE****30-22006**

## MARCHE-PIED 1 MARCHE 10" x 24" (+2")

- Marche-pied en aluminium
- Poids: 7 Lbs
- Longueur 24"
- Largeur 10"
- (+2") Au-dessus du niveau de l'attelage du véhicule

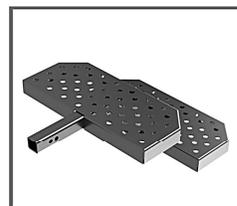
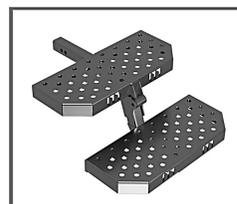
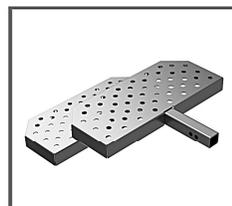
**MARCHE-PIED PIVOTANT  
2 MARCHES****30-22035**

## MARCHE-PIED PIVOTANT 2 MARCHES 10" x 24"

- Marche-pied en aluminium
- Poids: 17 Lbs
- 2 Marches: longueur de 24" et largeur de 10"

**MARCHE-PIED  
3 MARCHES**

**30-22033**

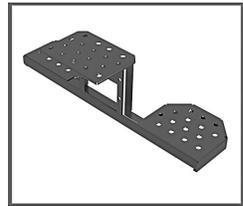
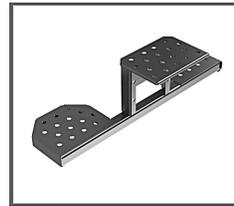
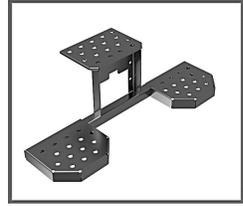
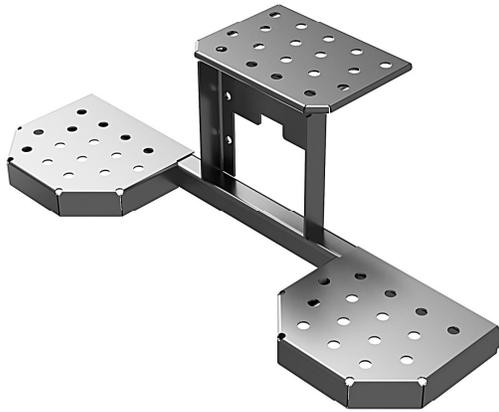

## **MARCHE-PIED 3 MARCHES EN ALUMINIUM**

- Mache-pied en aluminium
- Poids: 13 Lbs
- ( 2 Marches de 12"x 10" & 1 marche de 12"x 9")
- Hauteur: 12-1/2"
- Longueur: 39"
- Largeur: 18"