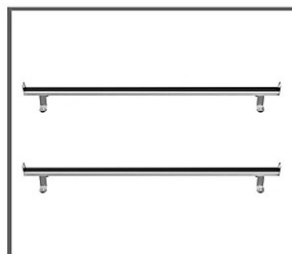
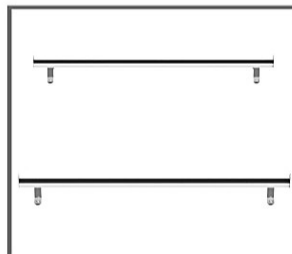

SUPPORT DE TOIT POUR CAMION
ET BIEN PLUS 1-855-835-2422
www.6sserden.com

30-10070-A

SUPPORT DE TOIT FIXE 55" ANODISÉ

- Matériel: Aluminium anodisé
- 2 Supports de toit fixe 55"
- Pour échelle, escabeau, kayak, ect...

30-10070-B

SUPPORT DE TOIT FIXE 55" BLANC

- Matériel: Aluminium anodisé blanc
- 2 Supports de toit fixe 55"
- Pour échelle, escabeau, kayak, ect...

30-10078

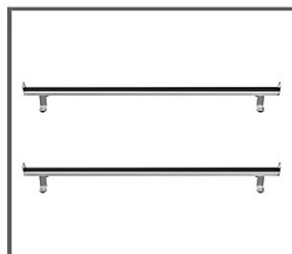
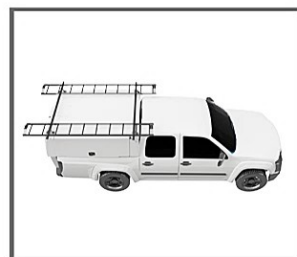

SUPPORT DE TOIT FIXE 72" DROIT ANODISÉ

- Matériel: Aluminium anodisé
- 2 Supports de toit fixe 72"
- Pour échelle, escabeau, kayak, ect...

30-10078-AV

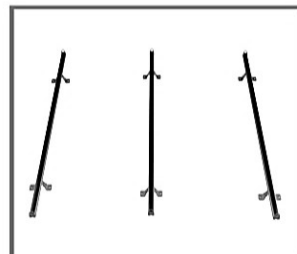
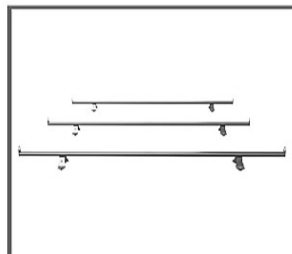
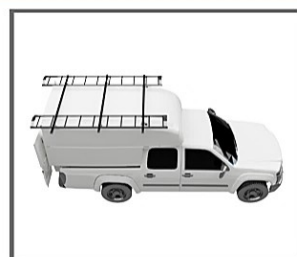
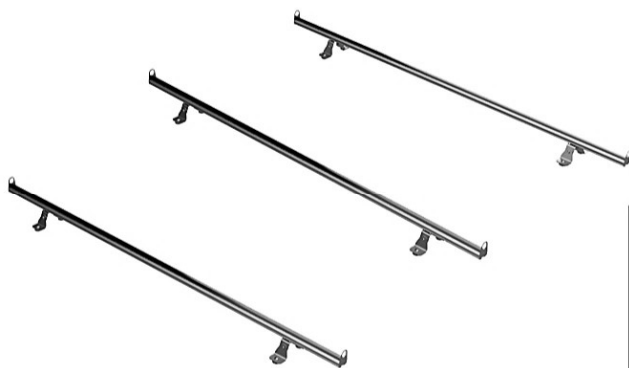

SUPPORT DE TOIT FIXE 72" DROIT ANODISÉ

- Matériel: Aluminium anodisé
- 3 Supports de toit fixe 72"
- Pour échelle, escabeau, kayak, ect...

30-10120

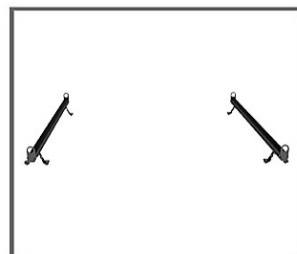
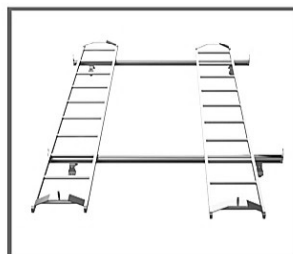
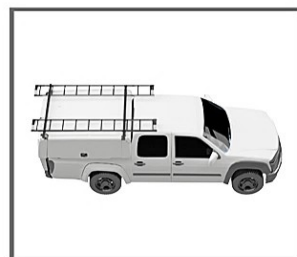

SUPPORT DE TOIT FIXE 70" DOUBLE

- Matériel: Aluminium anodisé
- 2 Supports de toit fixe 70" double extrusion
- Pour échelle, escabeau, kayak, ect...

30-10120-AV

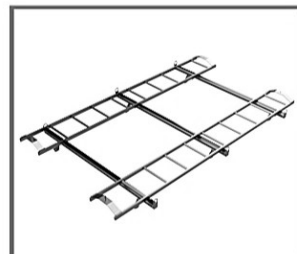
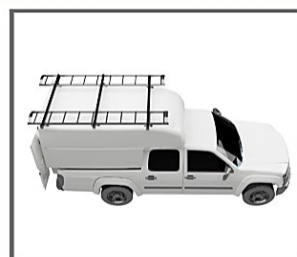

SUPPORT DE TOIT FIXE 70" DOUBLE

- Matériel: Aluminium anodisé
- 3 Supports de toit fixe 70" double extrusion
- Pour échelle, escabeau, kayak, ect...

30-10071

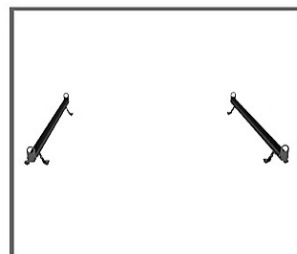
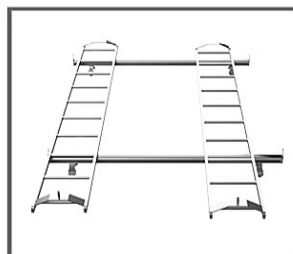
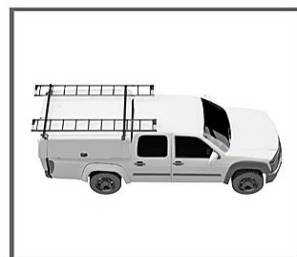
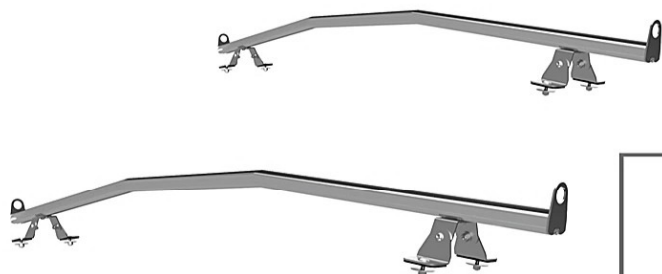

SUPPORT DE TOIT 72" AVEC COURBE

- Matériel: Aluminium anodisé
- 2 Supports de toit fixe 72" avec courbe de toit
- Pour échelle, escabeau, kayak, ect...

30-10071-AV

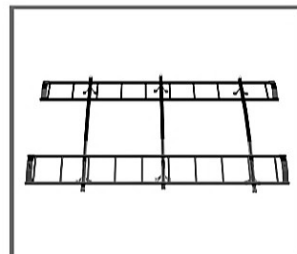
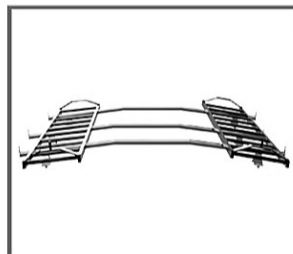
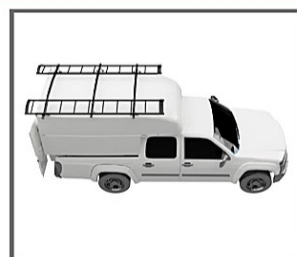

SUPPORT DE TOIT 72" AVEC COURBE

- Matériel: Aluminium anodisé
- 3 Supports de toit fixe 72" avec courbe de toit
- Pour échelle, escabeau, kayak, ect...

30-10208

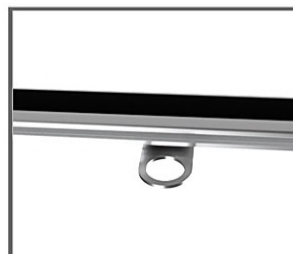

OEILLET SIMPLE POUR SUPPORT DE TOIT FIXE

- **Matériel: Acier inoxydable**
- **Une bonne solution pour ajouter de nombreuses possibilités de chargement pour vos supports de toit.**

30-10209

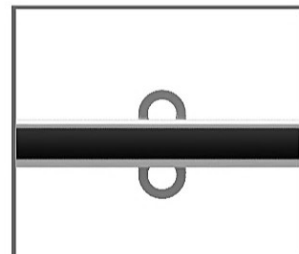
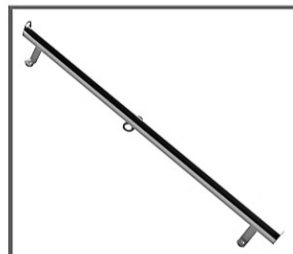
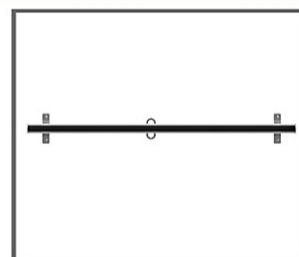
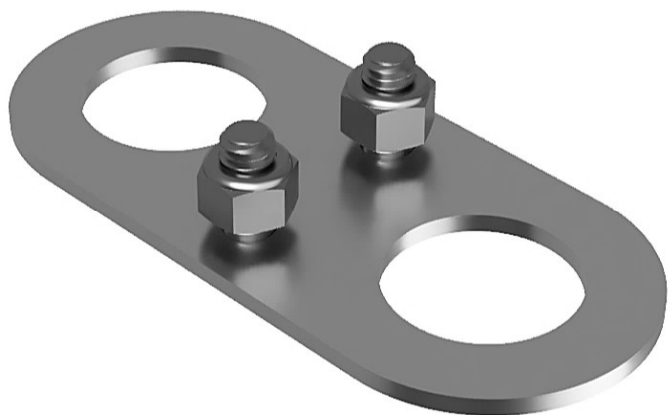

OEILLET DOUBLE POUR SUPPORT DE TOIT FIXE

- **Matériel: Acier inoxydable**
- **L'oeillet double permet un serrage accru avec des bandes à cliquets.**

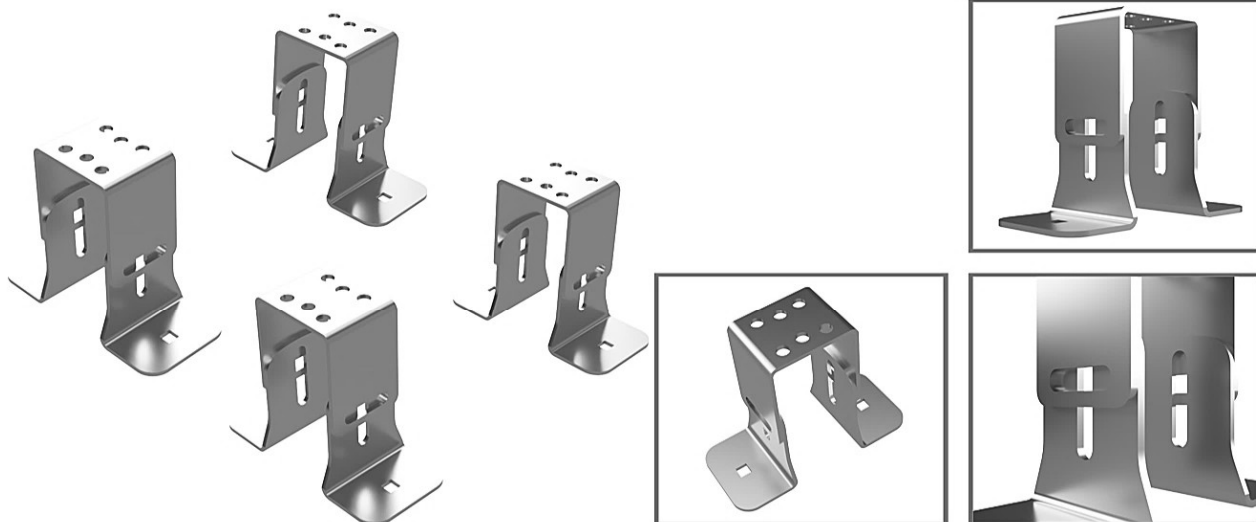
30-12210**ENSEMBLE DE 4 PATTES AJUSTABLES 4'' DE HAUT**

- Matériel: Acier inoxydable
- Pattes ajustables de 4'' de haut.
- Elles sont pratiques, fonctionnelles et réglables.

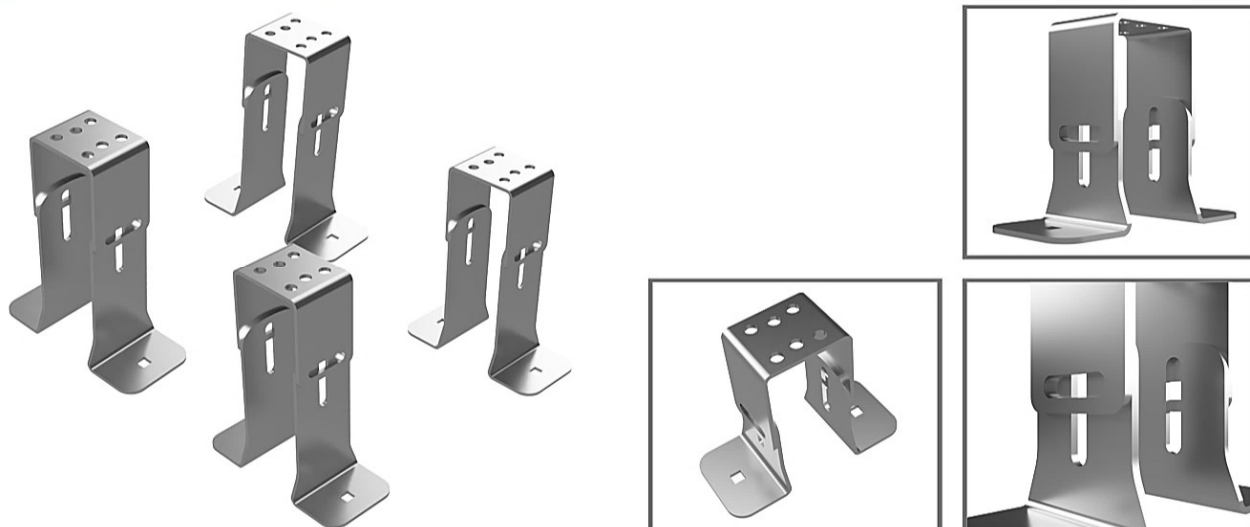
30-12220**ENSEMBLE DE PATTES AJUSTABLES 6'' DE HAUT**

- Matériel: Acier inoxydable
- Pattes ajustables de 6'' de haut.
- Elles sont pratiques, fonctionnelles et réglables.

30-12230

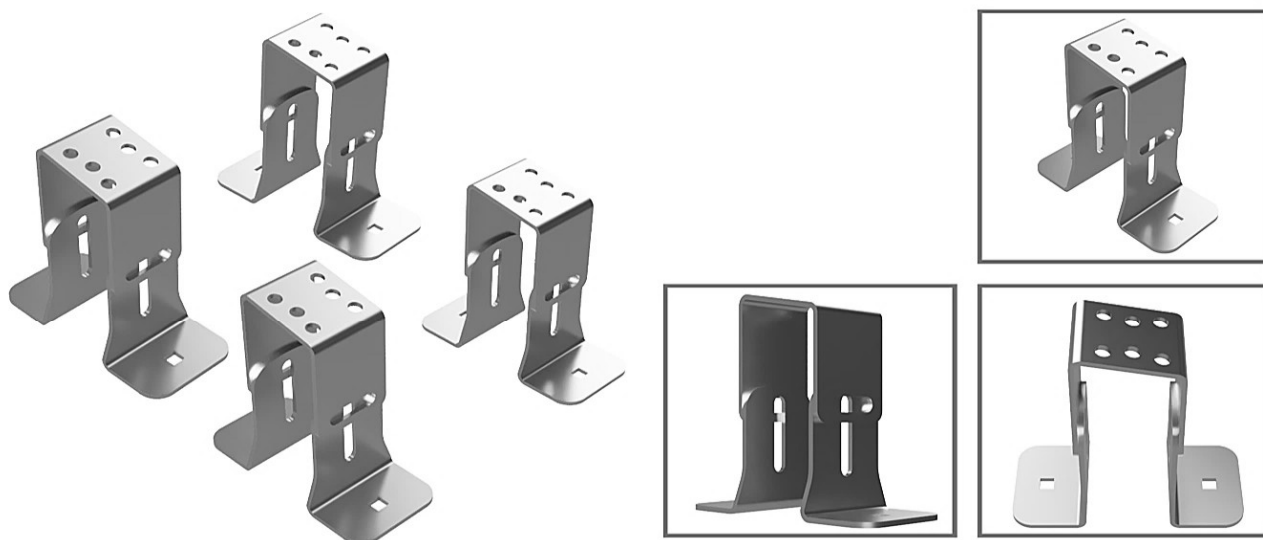

**ENSEMBLE DE 4 PATTES AJUSTABLES 4" DE HAUT
AVEC UN ANGLE DE 10 DEGRÉS**

- **Matériel: Acier inoxydable**
- **Pattes ajustables de 4" de haut. Avec angle de 10 degrés.**
- **Elles sont pratiques, fonctionnelles et réglables.**

30-12240

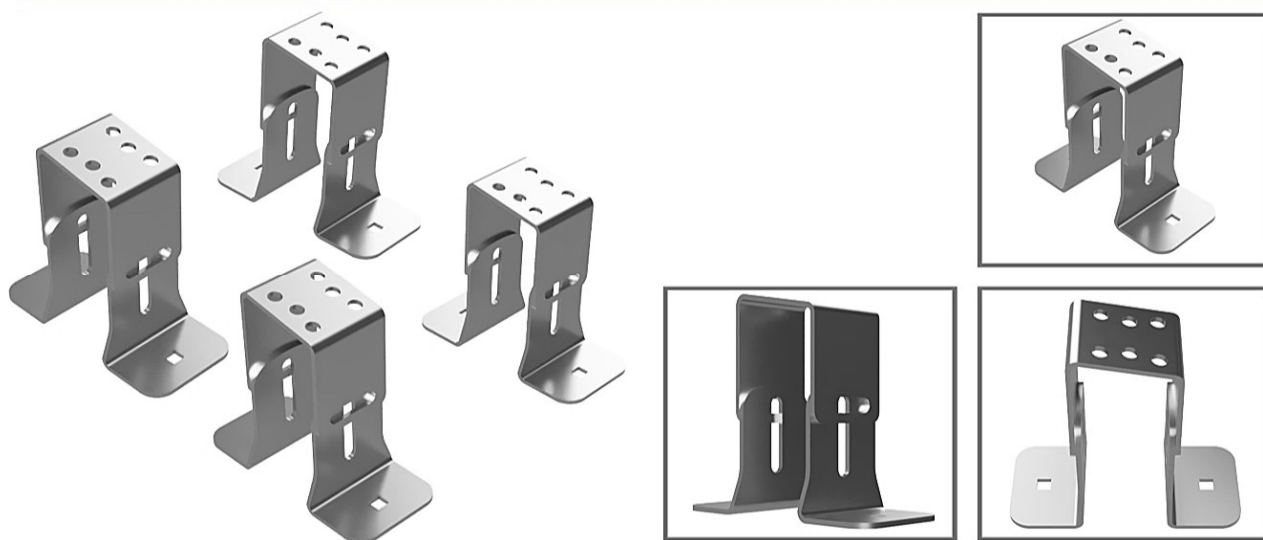

**ENSEMBLE DE 4 PATTES AJUSTABLES 6" DE HAUT
AVEC UN ANGLE DE 10 DEGRÉS**

- **Matériel: Acier inoxydable**
- **Pattes ajustables de 6" de haut. Avec angle de 10 degrés.**
- **Elles sont pratiques, fonctionnelles et réglables.**

30-10708

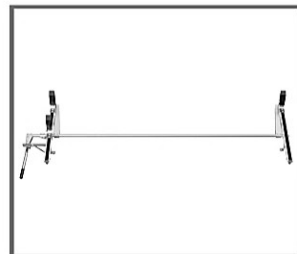
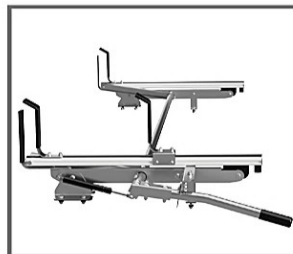
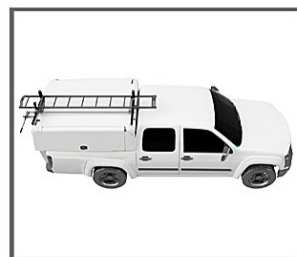
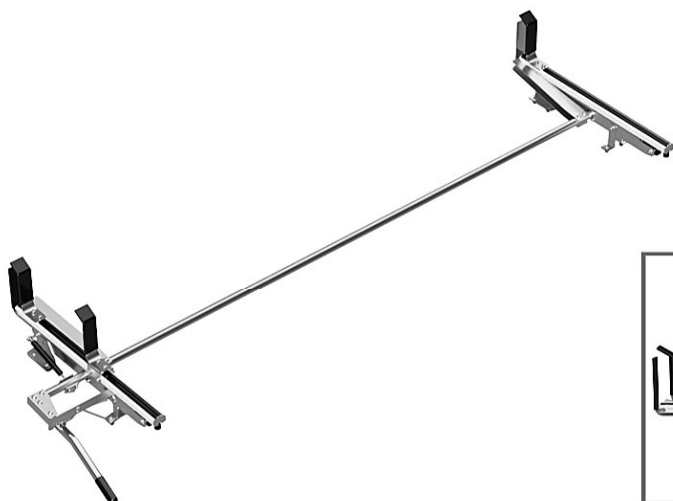

SUPPORT À ÉCHELLE ARTICULÉ M-170 PASSAGER

- Matériel: Aluminium anodisé
- Ensemble supp. à échelle articulé côté passager M-170
- Pour échelle de 10' à 28'

30-10702

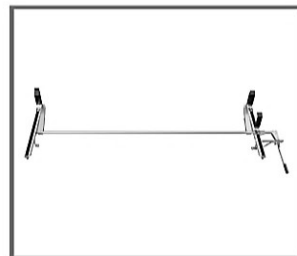
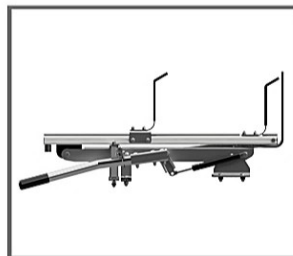
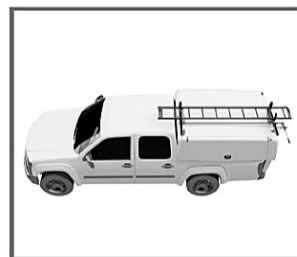
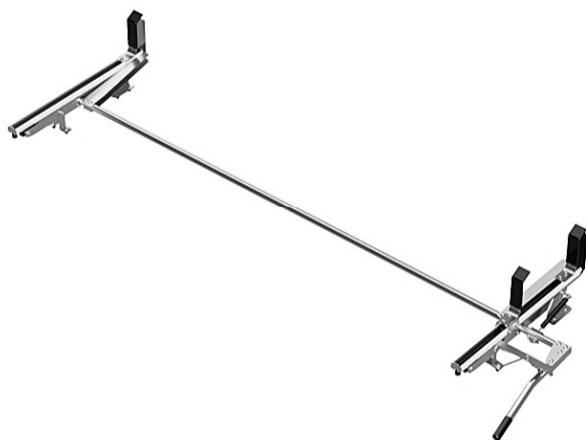

SUPPORT À ÉCHELLE ARTICULÉ M-170 CONDUCTEUR

- Matériel: Aluminium anodisé
- Ensemble supp. à échelle articulé côté conducteur M-170
- Pour échelle de 10' à 28'

30-10728

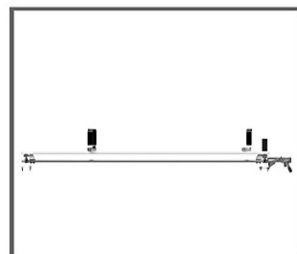
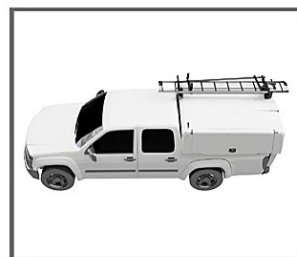

SUPPORT À ESCABEAU ARTICULÉ M-170 PASSAGER

- Matériel: Aluminium anodisé
- Ensemble supp. à escabeau articulé côté passager M-170
- Pour escabeau de 6' à 12'

30-10722

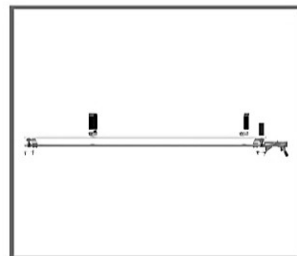
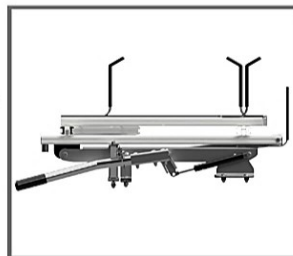
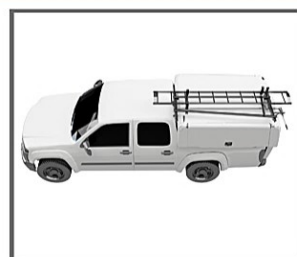

SUPPORT À ESCABEAU ARTICULÉ M-170 CONDUCTEUR

- Matériel: Aluminium anodisé
- Ensemble supp. à escabeau articulé côté conducteur M-170
- Pour escabeau de 6' à 12'

30-10708 & 30-10702

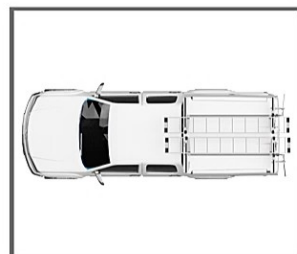
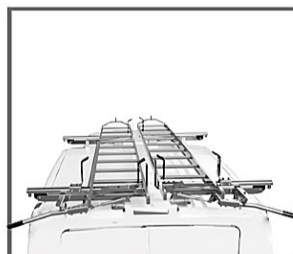
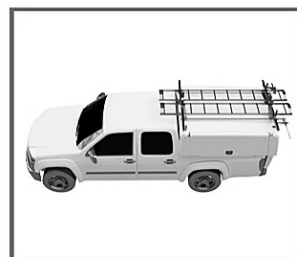

SUPPORTS À ÉCHELLES ARTICULÉS M-170

- Matériel: Aluminium anodisé
- Ensemble supp. à échelles articulés pour M-170
- Pour échelles de 10' à 28'

30-10728 & 30-10722

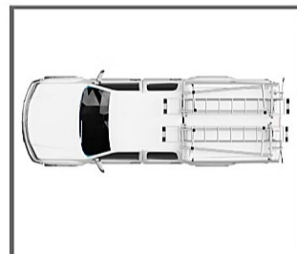
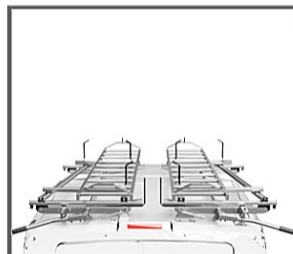
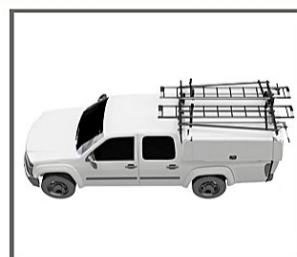

SUPPORTS À ESCABEAUX ARTICULÉS M-170

- Matériel: Aluminium anodisé
- Ensemble supp. à escabeaux articulés M-170
- Pour escabeaux de 6' à 12'

30-10702 & 30-10728

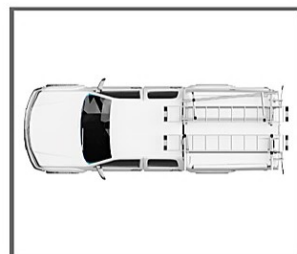
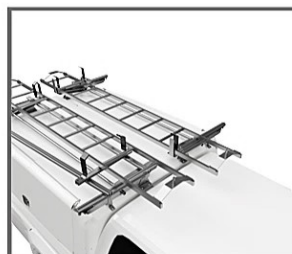
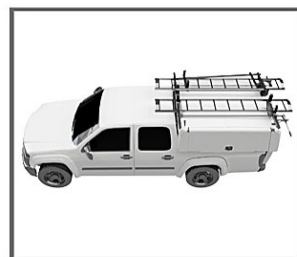

ENSEMBLE SUPPORT À ECHELLE ARTICULÉ CONDUCTEUR M-170
ENSEMBLE SUPPORT À ESCABEAU ARTICULÉ PASSAGER M-170

- **Matériel: Aluminium anodisé**
- **Ensemble supp. à échelle et escabeau**
- **Pour échelle de 10' à 28' et escabeau de 6' à 12'**

30-10708 & 30-10722

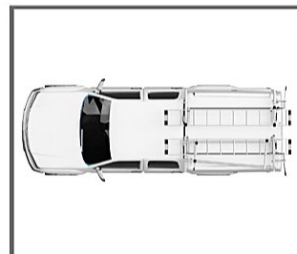
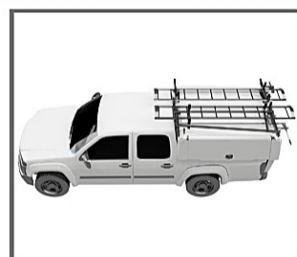

ENSEMBLE SUPPOT À ECHELLE ARTICULÉ PASSAGER M-170
ENSEMBLE SUPPORT À ESCABEAU ARTICULÉ CONDUCTEUR M-170

- **Matériel: Aluminium anodisé**
- **Ensemble supp. à échelle et escabeau**
- **Pour échelle de 10' à 28' et escabeau de 6' à 12'**

30-10701

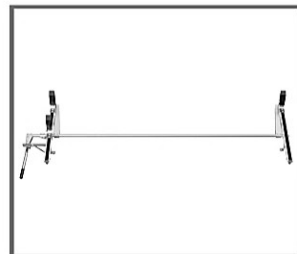
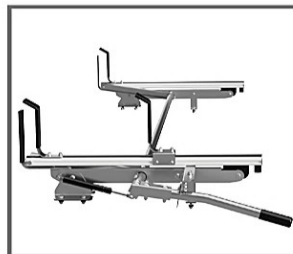
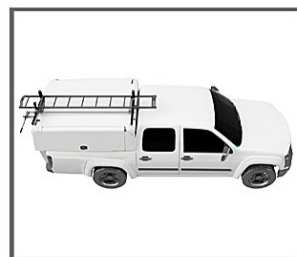
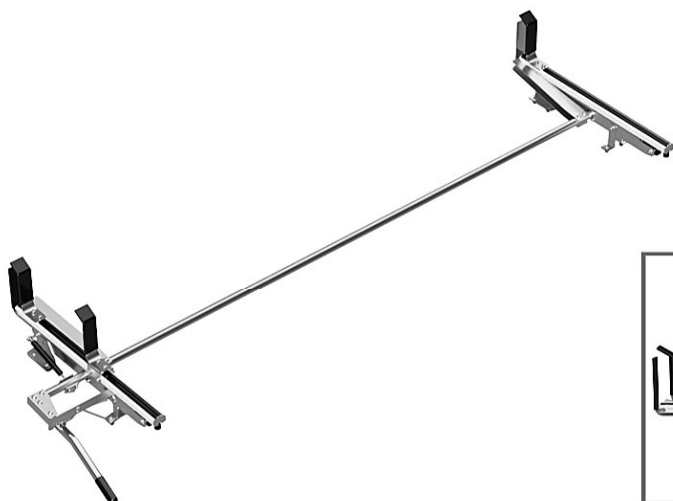

SUPPORT À ÉCHELLE ARTICULÉ M-140 PASSAGER

- Matériel: Aluminium anodisé
- Ensemble supp. à échelle articulé côté passager M-140
- Pour échelle de 10' à 28'

30-10707

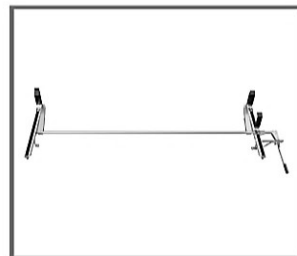
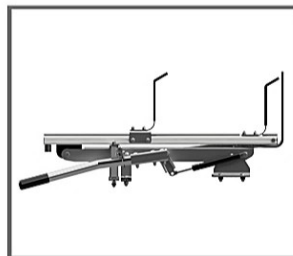
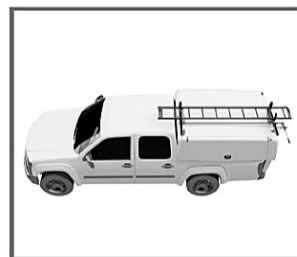
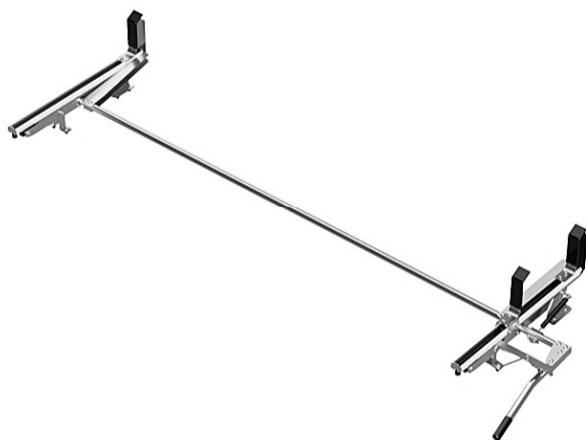

SUPPORT À ÉCHELLE ARTICULÉ M-140 CONDUCTEUR

- Matériel: Aluminium anodisé
- Ensemble supp. à échelle articulé côté conducteur M-140
- Pour échelle de 10' à 28'

30-10721

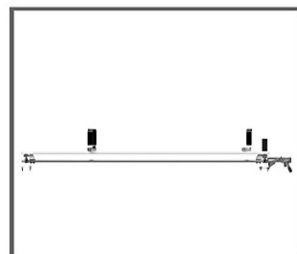
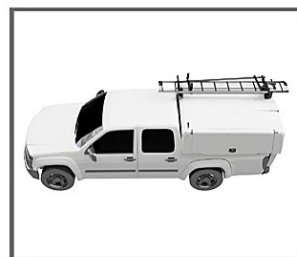

SUPPORT À ESCABEAU ARTICULÉ M-140 PASSAGER

- Matériel: Aluminium anodisé
- Ensemble supp. à escabeau articulé côté passager M-140
- Pour escabeau de 6' à 12'

30-10727

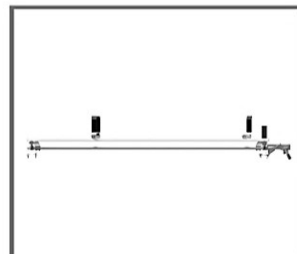
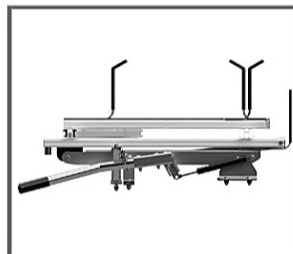
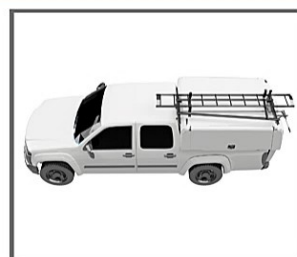

SUPPORT À ÉCHELLES ARTICULÉ M-140 CONDUCTEUR

- Matériel: Aluminium anodisé
- Ensemble supp. à échelle articulé côté conducteur M-140
- Pour escabeau de 6' à 12'

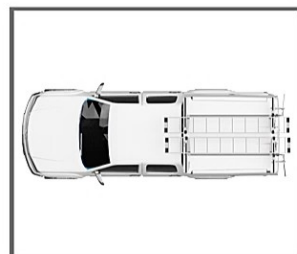
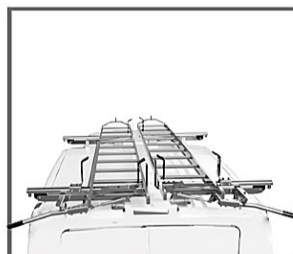
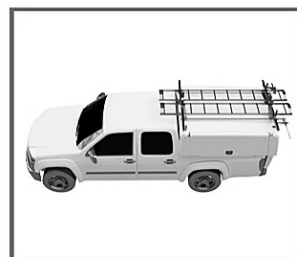
30-10701 & 30-10707

SUPPORTS À ÉCHELLES ARTICULÉS M-140

- Matériel: Aluminium anodisé
- Ensemble supp. à échelles articulés pour M-140
- Pour échelles de 10' à 28'

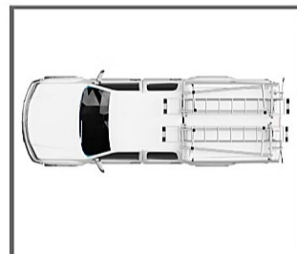
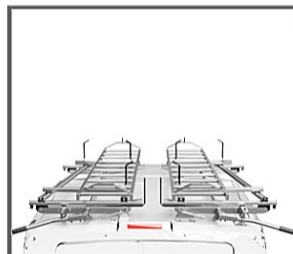
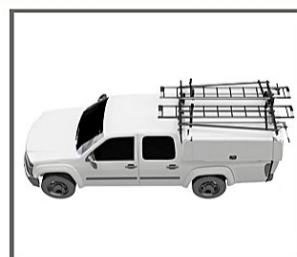
30-10721 & 30-10727

SUPPORTS À ESCABEAUX ARTICULÉS M-140

- Matériel: Aluminium anodisé
- Ensemble supp. à escabeaux articulés M-140
- Pour escabeaux 6' à 12'

30-10707 & 30-10721

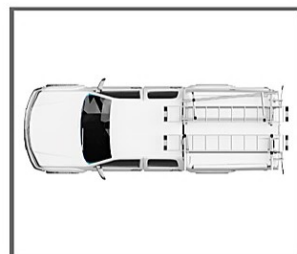
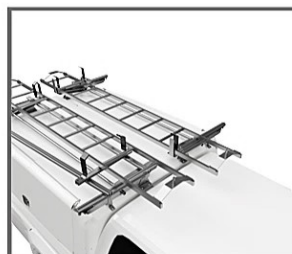
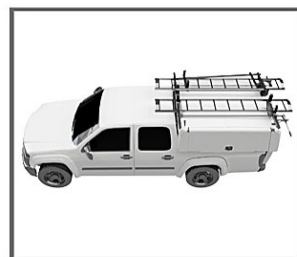

ENSEMBLE SUPPORT À ECHELLE ARTICULÉ CONDUCTEUR M-140
ENSEMBLE SUPPORT À ESCABEAU ARTICULÉ PASSAGER M-140

- **Matériel: Aluminium anodisé**
- **Ensemble supp. à échelle et escabeau**
- **Pour échelle de 10' à 28', escabeau de 6' à 12'**

30-10701 & 30-10727

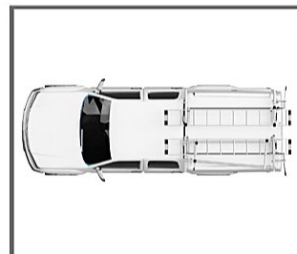
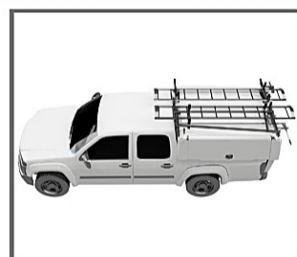

ENSEMBLE SUPPOT À ECHELLE ARTICULÉ PASSAGER M-140
ENSEMBLE SUPPORT À ESCABEAU ARTICULÉ CONDUCTEUR M-140

- **Matériel: Aluminium anodisé**
- **Ensemble supp. à échelle et escabeau**
- **Pour échelle de 10' à 28', escabeau de 6' à 12'**

30-11020

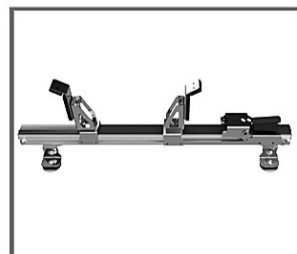
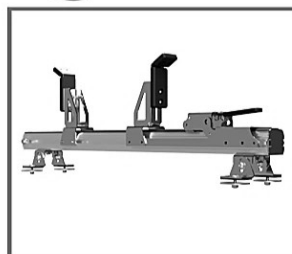
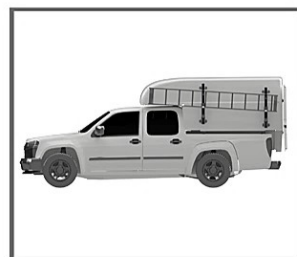
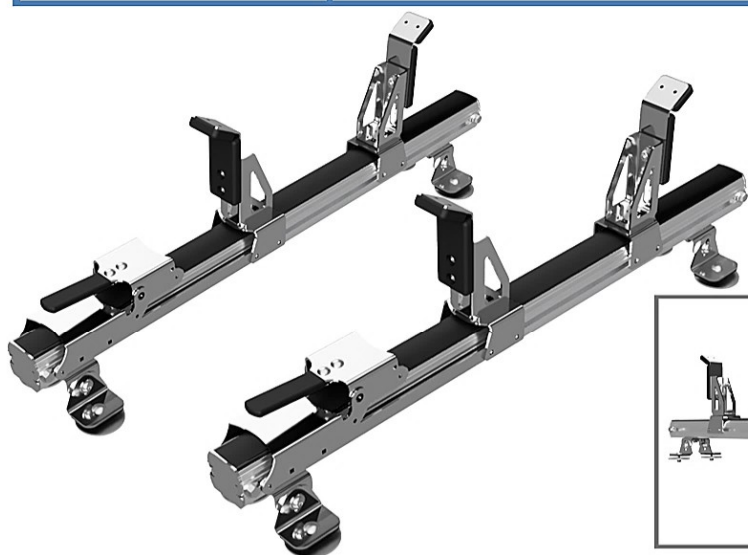

SUPPORT DE CÔTÉ POUR ÉCHELLE OU ESCABEAU

- Matériel: Aluminium anodisé
- Ensemble supp. à échelle ou escabeau
- Pour échelle de 10' à 28', escabeau de 6' à 12'

30-11050

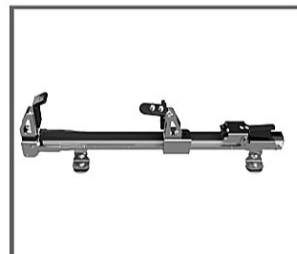
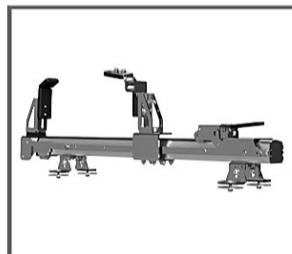
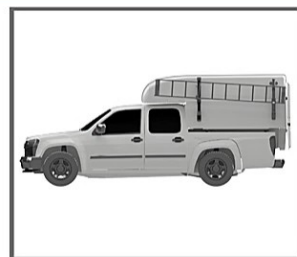

SUPPORT DE CÔTÉ PRO POUR ÉCHELLE OU ESCABEAU

- Matériel: Aluminium anodisé
- Ensemble supp. à échelle ou escabeau
- Pour échelle de 10' à 28', escabeau de 6' à 12'

30-13679

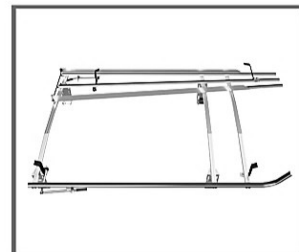
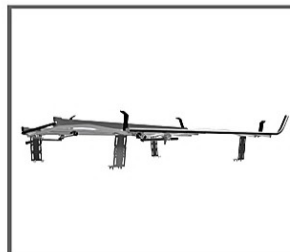
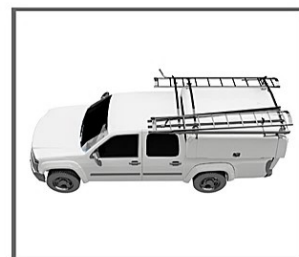

ENSEMBLE SUPPORT DE TOIT ESCABEAU & ÉCHELLE

- Matériel: Aluminium anodisé
- Assemblage final rack universel 72" large par 84" long
- Escabeau coté conducteur et échelle coté passager

???

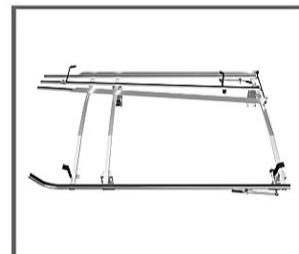
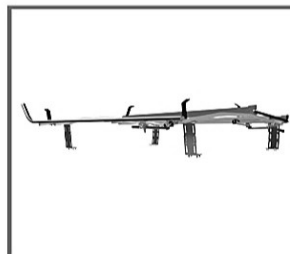
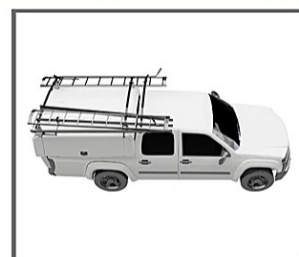
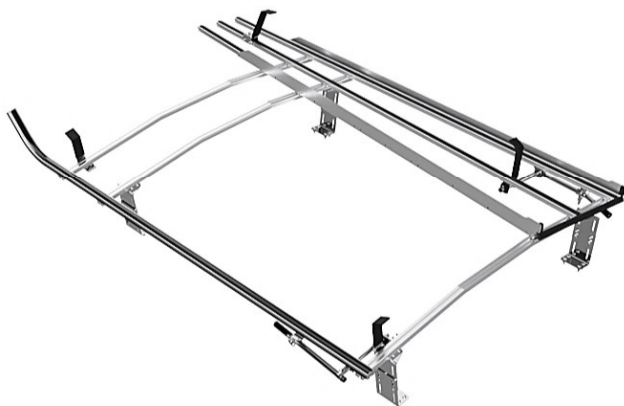

ENSEMBLE SUPPORT DE TOIT ESCABEAU & ÉCHELLE

- Matériel: Aluminium anodisé
- Assemblage final rack universel 72" large par 84" long
- Escabeau coté passager et échelle coté conducteur

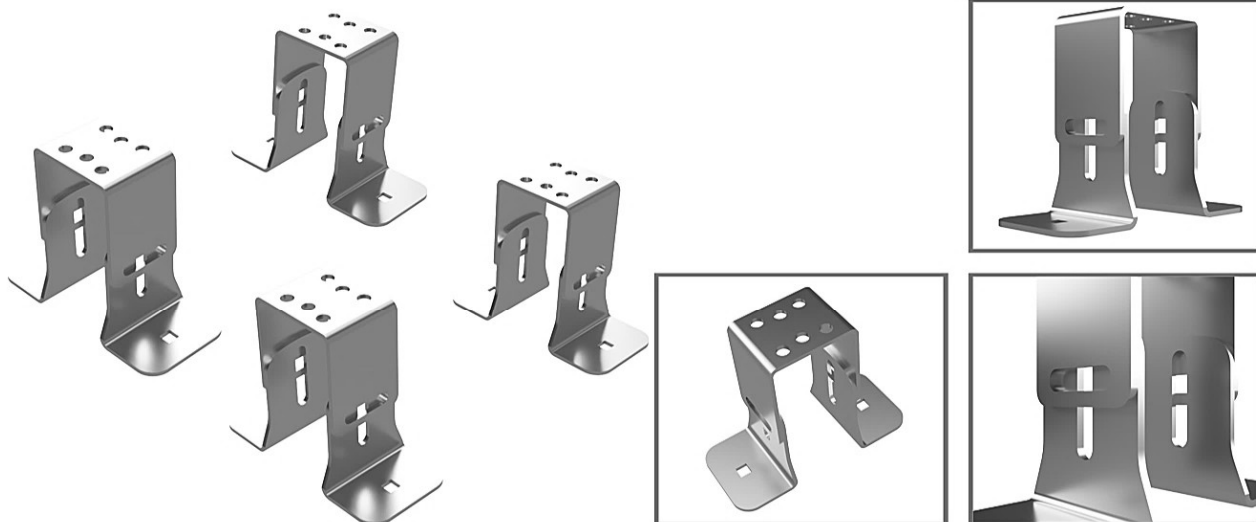
30-12210**ENSEMBLE DE 4 PATTES AJUSTABLES 4'' DE HAUT**

- Matériel: Acier inoxydable
- Pattes ajustables de 4'' de haut.
- Elles sont pratiques, fonctionnelles et réglables.

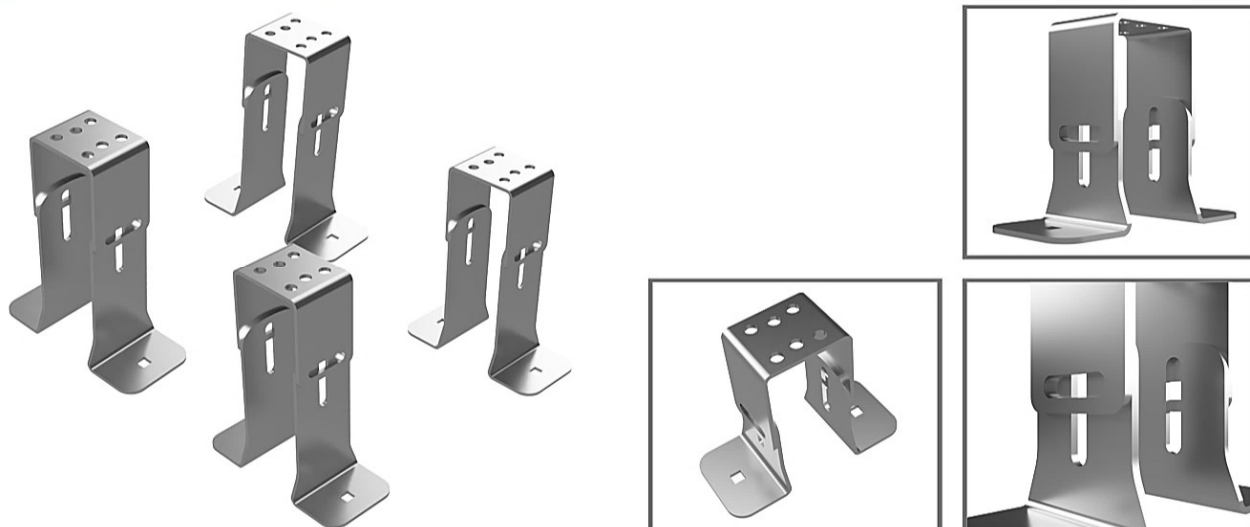
30-12220**ENSEMBLE DE 4 PATTES AJUSTABLES 6'' DE HAUT**

- Matériel: Acier inoxydable
- Pattes ajustables de 6'' de haut.
- Elles sont pratiques, fonctionnelles et réglables.