

ÉTAGÈRE EN ALUMINIUM
ET BIEN PLUS

59" DE HAUT

1-855-835-2422
www.6sserden.com

ENSEMBLE DE BASE - 59''H x 24''Long.

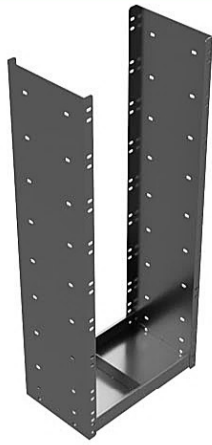

PORTE



20-21620 - 13'' DE PROFOND 13''

20-21820 - 15'' DE PROFOND 15''

28-28316 - 12''H x 21''L

TABLETTE ADDITIONNELLE - 24''Long.

*INCLUS 1 SÉPARATEURS PAR TABLETTE



MUR SÉPARATEUR



28-21020 - 13'' DE PROFOND 13''

28-21030 - 15'' DE PROFOND 15''

20-62003 - 14''H x 13'' DE PROFOND 13''

20-62004 - 14''H x 15'' DE PROFOND 15''

SÉPARATEUR

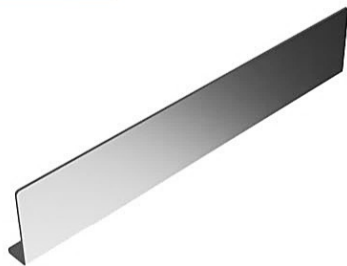

DOSSERET



21-41003 - 2 1/2''H x 13'' DE PROFOND 13''

21-41004 - 2 1/2''H x 15'' DE PROFOND 15''

20-61030 - 59''H x 24''L

BAC BLEU



PETIT - 1 à 5 Bacs par tab. 24''
28-33001 - 3''H x 7 1/4'' DE PROFOND 13''

MOYEN - 1 à 4 Bacs par tab. 24''
28-33002 - 5''H x 10 3/4'' DE PROFOND 13''

GRAND - 1 à 2 Bacs par tab. 24''
28-33003 - 7''H x 14 5/8'' DE PROFOND 15''

ENSEMBLE DE BASE - 59''H x 36''Long.



PORTE

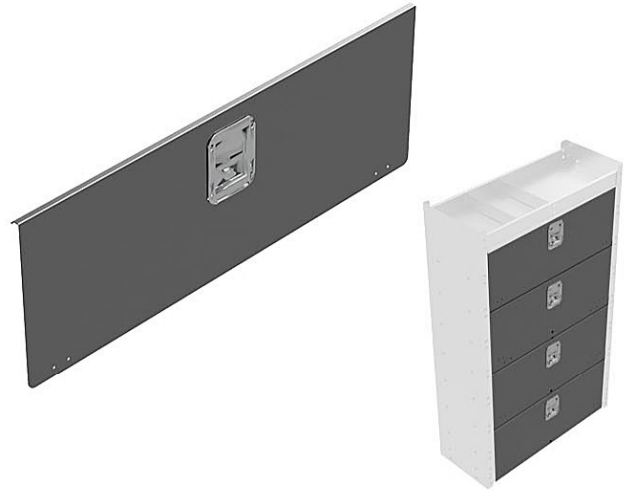

20-21621 - 13'' DE PROFOND 13''

20-21821 - 15'' DE PROFOND 15''

28-28502 - 12''H x 33''L

TABLETTE ADDITIONNELLE - 36''Long.

*INCLUS 2 SÉPARATEURS PAR TABLETTE



28-21021 - 13'' DE PROFOND 13''

28-21031 - 15'' DE PROFOND 15''

MUR SÉPARATEUR



20-62003 - 14''H x 13'' DE PROFOND 13''

20-62004 - 14''H x 15'' DE PROFOND 15''

SÉPARATEUR

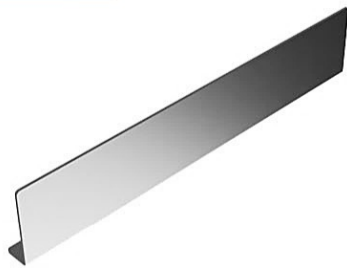

21-41003 - 2 1/2''H x 13'' DE PROFOND 13''

21-41004 - 2 1/2''H x 15'' DE PROFOND 15''

DOSSERET



20-61031 - 59''H x 36''L

BAC BLEU



PETIT - 1 à 8 Bacs par tab. 36''
28-33001 - 3''H x 7 1/4'' DE PROFOND 13''

MOYEN - 1 à 6 Bacs par tab. 36''
28-33002 - 5''H x 10 3/4'' DE PROFOND 13''

GRAND - 1 à 4 Bacs par tab. 36''
28-33003 - 7''H x 14 5/8'' DE PROFOND 15''

ENSEMBLE DE BASE - 59" H x 42" Long.



20-21622 - 13" DE PROFOND 13"

20-21822 - 15" DE PROFOND 15"

PORTE

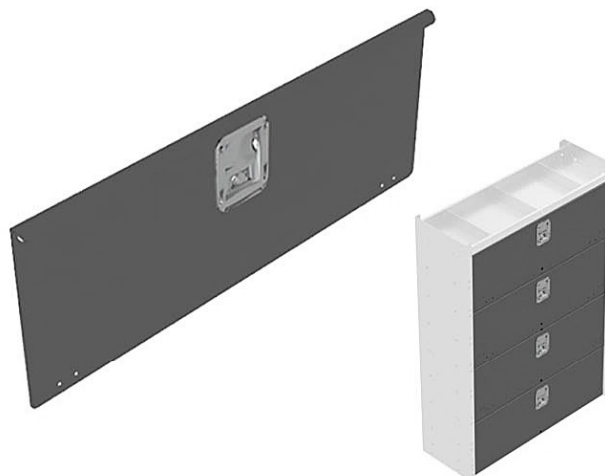

28-28304 - 12" H x 39" L

TABLETTE ADDITIONNELLE - 42" Long.

*INCLUS 3 SÉPARATEURS PAR TABLETTE



28-21022 - 13" DE PROFOND 13"

28-21032 - 15" DE PROFOND 15"

MUR SÉPARATEUR



20-62003 - 14" H x 13" DE PROFOND 13"

20-62004 - 14" H x 15" DE PROFOND 15"

SÉPARATEUR

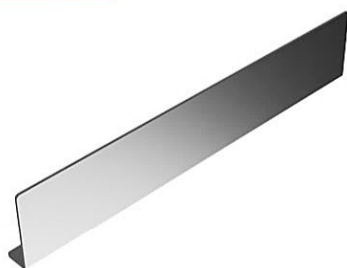

21-41003 - 2 1/2" H x 13" DE PROFOND 13"

21-41004 - 2 1/2" H x 15" DE PROFOND 15"

DOSSERET



20-61032 - 59" H x 42" L

BAC BLEU



PETIT - 1 à 9 Bacs par tab. 42"
28-33001 - 3" H x 7 1/4" DE PROFOND 13"

MOYEN - 1 à 7 Bacs par tab. 42"
28-33002 - 5" H x 10 3/4" DE PROFOND 13"

GRAND - 1 à 5 Bacs par tab. 42"
28-33003 - 7" H x 14 5/8" DE PROFOND 15"

ENSEMBLE DE BASE - 59''H x 48''Long.



20-21623 - 13'' DE PROFOND 13''

20-21823 - 15'' DE PROFOND 15''

PORTE

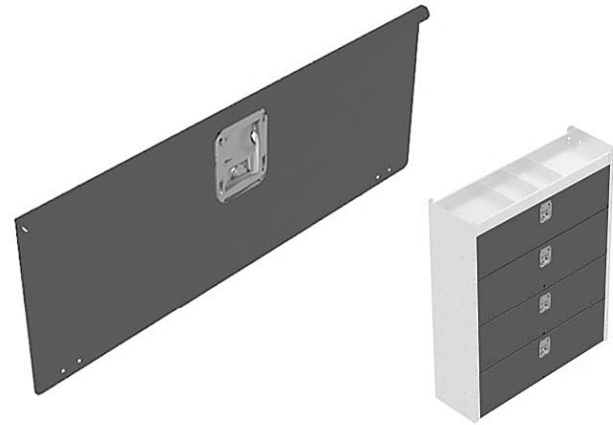

28-28307 - 12''H x 45''L

TABLETTE ADDITIONNELLE - 48''Long.

*INCLUS 3 SÉPARATEURS PAR TABLETTE



28-21023 - 13'' DE PROFOND 13''

28-21033 - 15'' DE PROFOND 15''

MUR SÉPARATEUR



20-62003 - 14''H x 13'' DE PROFOND 13''

20-62004 - 14''H x 15'' DE PROFOND 15''

SÉPARATEUR

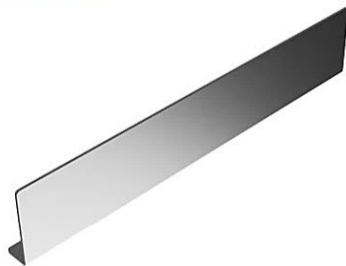

21-41003 - 2 1/2''H x 13'' DE PROFOND 13''

21-41004 - 2 1/2''H x 15'' DE PROFOND 15''

DOSSERET



20-61033 - 59''H x 48''L

BAC BLEU



PETIT - 1 à 11 Bacs par tab. 48''
28-33001 - 3''H x 7 1/4'' DE PROFOND 13''

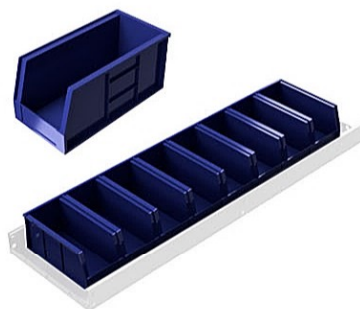

MOYEN - 1 à 8 Bacs par tab. 48''
28-33002 - 5''H x 10 3/4'' DE PROFOND 13''



GRAND - 1 à 5 Bacs par tab. 48''
28-33003 - 7''H x 14 5/8'' DE PROFOND 15''

ENSEMBLE DE BASE - 59''H x 60''Long.

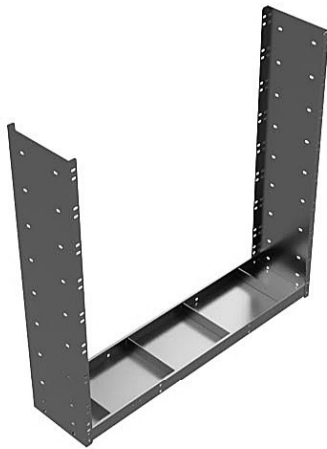

20-21624 - 13'' DE PROFOND 13''

20-21824 - 15'' DE PROFOND 15''

PORTE

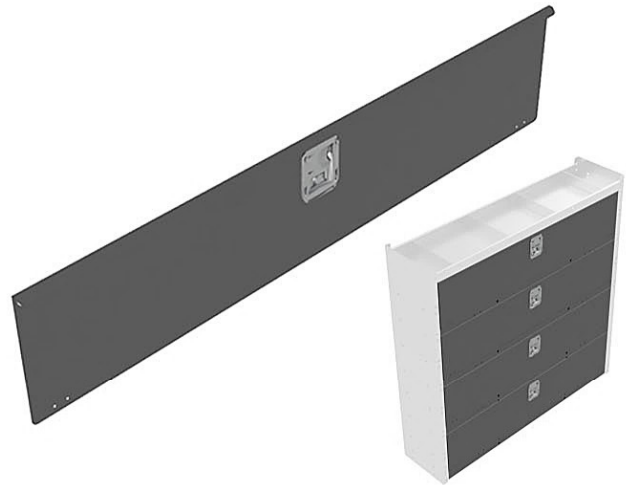

28-28308 - 12''H x 57''L

TABLETTE ADDITIONNELLE - 60''Long.

*INCLUS 4 SÉPARATEURS PAR TABLETTE



28-21024 - 13'' DE PROFOND 13''

28-21034 - 15'' DE PROFOND 15''

MUR SÉPARATEUR



20-62003 - 14''H x 13'' DE PROFOND 13''

20-62004 - 14''H x 15'' DE PROFOND 15''

SÉPARATEUR

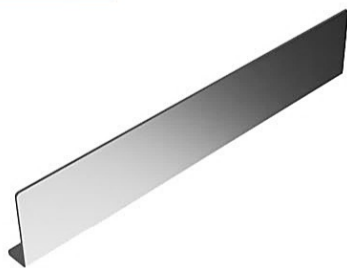

21-41003 - 2 1/2''H x 13'' DE PROFOND 13''

21-41004 - 2 1/2''H x 15'' DE PROFOND 15''

DOSSERET



20-61034 - 59''H x 60''L

BAC BLEU



PETIT - 1 à 13 Bacs par tab. 60''
28-33001 - 3''H x 7 1/4'' DE PROFOND 13''

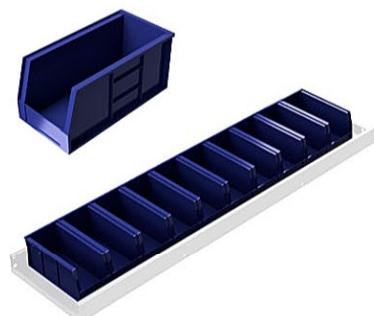

MOYEN - 1 à 10 Bacs par tab. 60''
28-33002 - 5''H x 10 3/4'' DE PROFOND 13''



GRAND - 1 à 6 Bacs par tab. 60''
28-33003 - 7''H x 14 5/8'' DE PROFOND 15''

ENSEMBLE DE BASE - 59''H x 72''Long.



20-21625 - 13'' DE PROFOND 13''

20-21825 - 15'' DE PROFOND 15''

PORTE

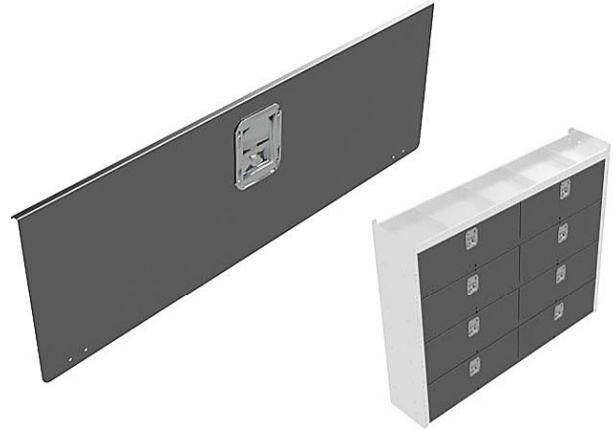

28-28306 - 12''H x 34 3/8''L

TABLETTE ADDITIONNELLE - 72''Long.

*INCLUS 5 SÉPARATEURS PAR TABLETTE



28-21027 - 13'' DE PROFOND 13''

28-21037 - 15'' DE PROFOND 15''

MUR SÉPARATEUR

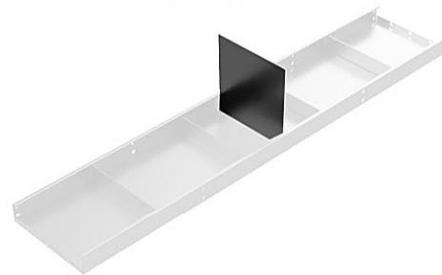

20-62003 - 14''H x 13'' DE PROFOND 13''

20-62004 - 14''H x 15'' DE PROFOND 15''

SÉPARATEUR

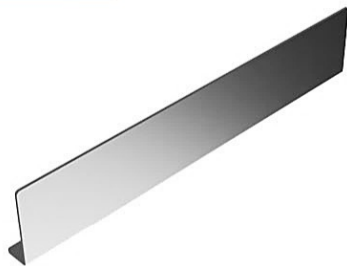

21-41003 - 2 1/2''H x 13'' DE PROFOND 13''

21-41004 - 2 1/2''H x 15'' DE PROFOND 15''

DOSSERET



20-61035 - 59''H x 72''L

BAC BLEU

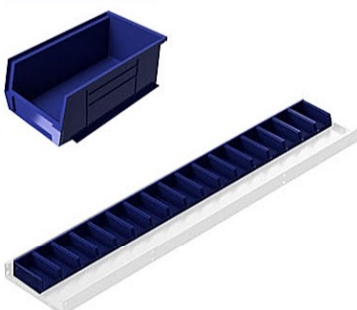

PETIT - 1 à 16 Bacs par tab. 72''
28-33001 - 3''H x 7 1/4'' DE PROFOND 13''

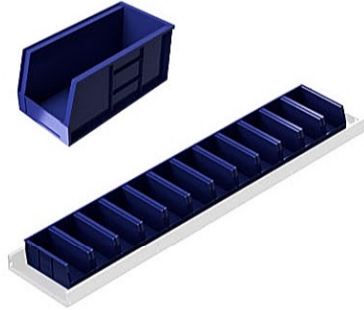

MOYEN - 1 à 12 Bacs par tab. 72''
28-33002 - 5''H x 10 3/4'' DE PROFOND 13''



GRAND - 1 à 8 Bacs par tab. 72''
28-33003 - 7''H x 14 5/8'' DE PROFOND 15''

ENSEMBLE DE BASE - 59''H x 84''Long.

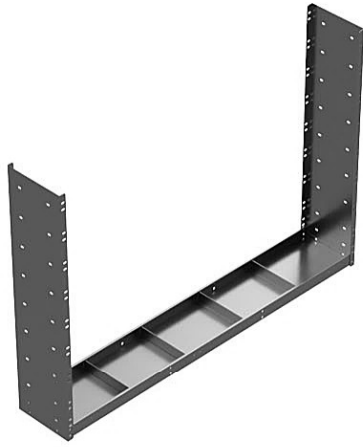

20-21626 - 13'' DE PROFOND 13''

20-21826 - 15'' DE PROFOND 15''

PORTE

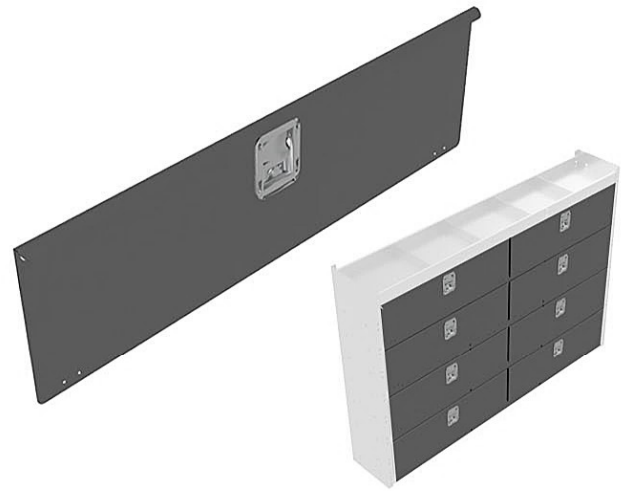

28-28309 - 12''H x 40''L

TABLETTE ADDITIONNELLE - 84''Long.

*INCLUS 5 SÉPARATEURS PAR TABLETTE

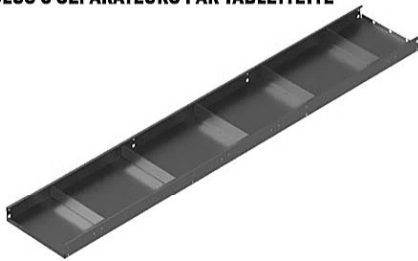

28-21026 - 13'' DE PROFOND 13''

28-21036 - 15'' DE PROFOND 15''

MUR SÉPARATEUR

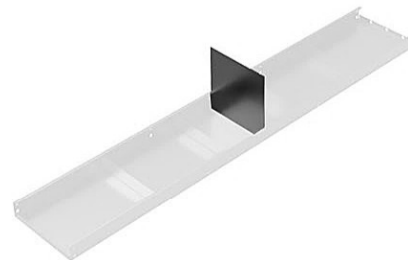

20-62003 - 14''H x 13'' DE PROFOND 13''

20-62004 - 14''H x 15'' DE PROFOND 15''

SÉPARATEUR

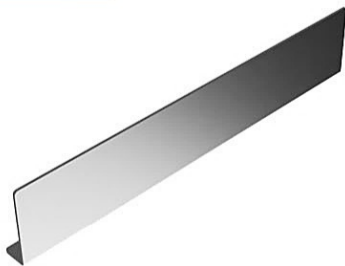

21-41003 - 2 1/2''H x 13'' DE PROFOND 13''

21-41004 - 2 1/2''H x 15'' DE PROFOND 15''

DOSSERET

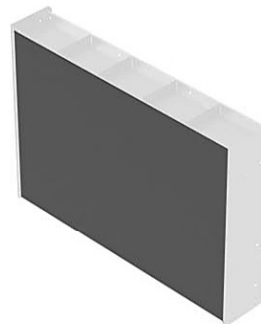

20-61036 - 59''H x 84''L

BAC BLEU

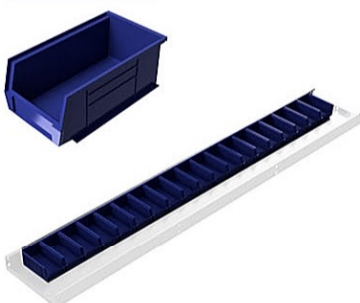

PETIT - 1 à 19 Bacs par tab. 84''
28-33001 - 3''H x 7 1/4'' DE PROFOND 13''

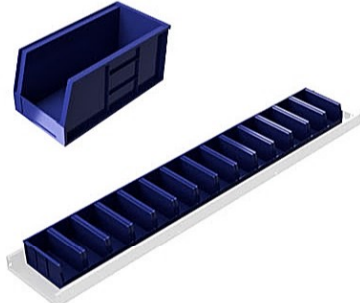

MOYEN - 1 à 14 Bacs par tab. 84''
28-33002 - 5''H x 10 3/4'' DE PROFOND 13''

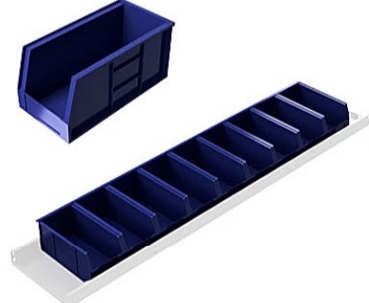

GRAND - 1 à 9 Bacs par tab. 84''
28-33003 - 7''H x 14 5/8'' DE PROFOND 15''

ENSEMBLE DE BASE - 59" H x 92" Long.

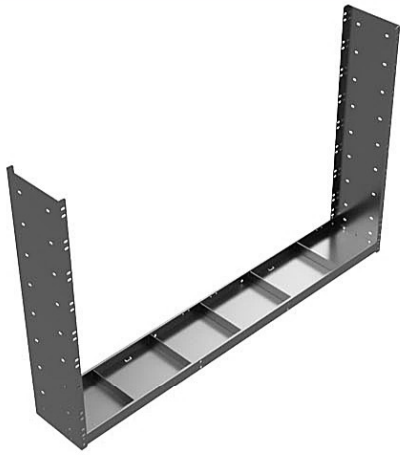

20-21627 - 13" DE PROFOND 13"

20-21827 - 15" DE PROFOND 15"

PORTE

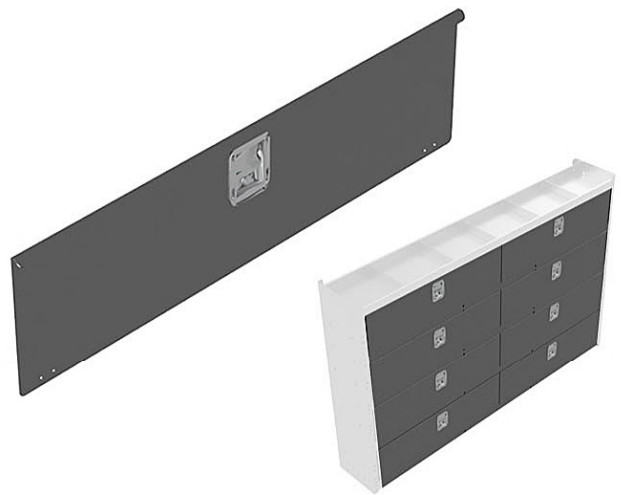

28-28310 - 12" H x 44" L

TABLETTE ADDITIONNELLE - 92" Long.

* INCLUS 6 SÉPARATEURS PAR TABLETTE



28-21027 - 13" DE PROFOND 13"

28-21037 - 15" DE PROFOND 15"

MUR SÉPARATEUR

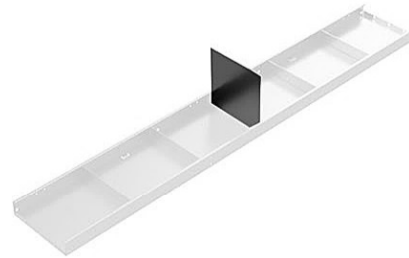

20-62003 - 14" H x 13" DE PROFOND 13"

20-62004 - 14" H x 15" DE PROFOND 15"

SÉPARATEUR

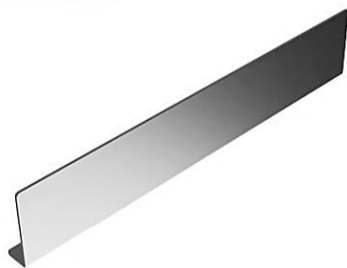

21-41003 - 2 1/2" H x 13" DE PROFOND 13"

21-41004 - 2 1/2" H x 15" DE PROFOND 15"

DOSSERET



20-61037 - 59" H x 92" L

BAC BLEU

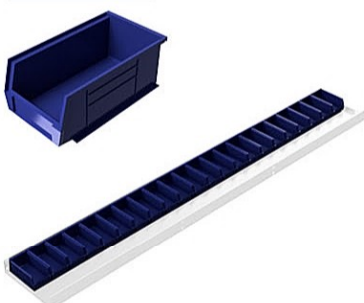

PETIT - 1 à 22 Bacs par tab. 92"
28-33001 - 3" H x 7 1/4" DE PROFOND 13"

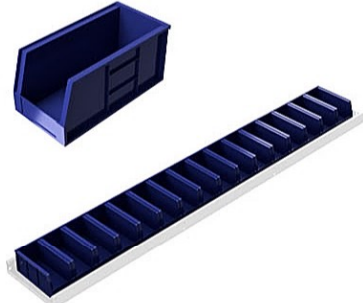

MOYEN - 1 à 16 Bacs par tab. 92"
28-33002 - 5" H x 10 3/4" DE PROFOND 13"



GRAND - 1 à 11 Bacs par tab. 92"
28-33003 - 7" H x 14 5/8" DE PROFOND 15"