

ÉTAGÈRE EN ALUMINIUM
ET BIEN PLUS

28" DE HAUT

1-855-835-2422
www.6sserden.com

ENSEMBLE DE BASE - 28''H x 24''Long.



20-21320 - 13'' DE PROFOND 13''

20-21331 - 15'' DE PROFOND 15''

PORTE



28-28316 - 12''H x 21''L

TABLETTE ADDITIONNELLE - 24''Long.

*INCLUS 1 SÉPARATEURS PAR TABLETTE



28-21020 - 13'' DE PROFOND 13''

28-21030 - 15'' DE PROFOND 15''

MUR SÉPARATEUR



20-62003 - 14''H x 13'' DE PROFOND 13''

20-62004 - 14''H x 15'' DE PROFOND 15''

SÉPARATEUR

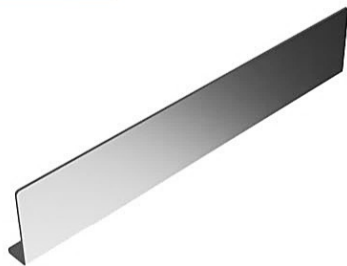

21-41003 - 2 1/2''H x 13'' DE PROFOND 13''

21-41004 - 2 1/2''H x 15'' DE PROFOND 15''

DOSSERET

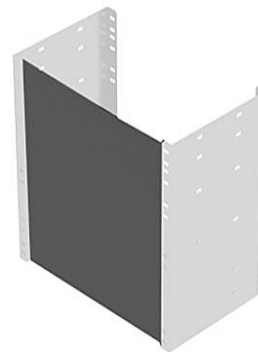

20-61010 - 28''H x 24''L

BAC BLEU



PETIT - 1 à 5 Bacs par tab. 24''
28-33001 - 3''H x 7 1/4'' DE PROFOND 13''

MOYEN - 1 à 4 Bacs par tab. 24''
28-33002 - 5''H x 10 3/4'' DE PROFOND 13''

GRAND - 1 à 2 Bacs par tab. 24''
28-33003 - 7''H x 14 5/8'' DE PROFOND 15''

ENSEMBLE DE BASE - 28''H x 36''Long.

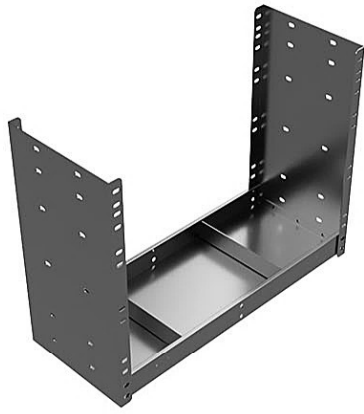

20-21321 - 13'' DE PROFOND 13''

20-21330 - 15'' DE PROFOND 15''

TABLETTE ADDITIONNELLE - 36''Long.

*INCLUS 2 SÉPARATEURS PAR TABLETTE



28-21021 - 13'' DE PROFOND 13''

28-21031 - 15'' DE PROFOND 15''

SÉPARATEUR

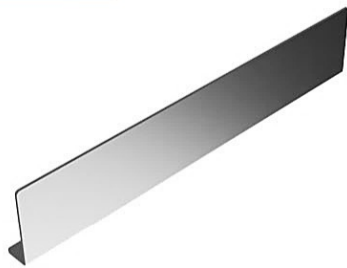

21-41003 - 2 1/2''H x 13'' DE PROFOND 13''

21-41004 - 2 1/2''H x 15'' DE PROFOND 15''

BAC BLEU



PETIT - 1 à 8 Bacs par tab. 36''
28-33001 - 3''H x 7 1/4'' DE PROFOND 13''



MOYEN - 1 à 6 Bacs par tab. 36''
28-33002 - 5''H x 10 3/4'' DE PROFOND 13''



GRAND - 1 à 4 Bacs par tab. 36''
28-33003 - 7''H x 14 5/8'' DE PROFOND 15''

PORTE

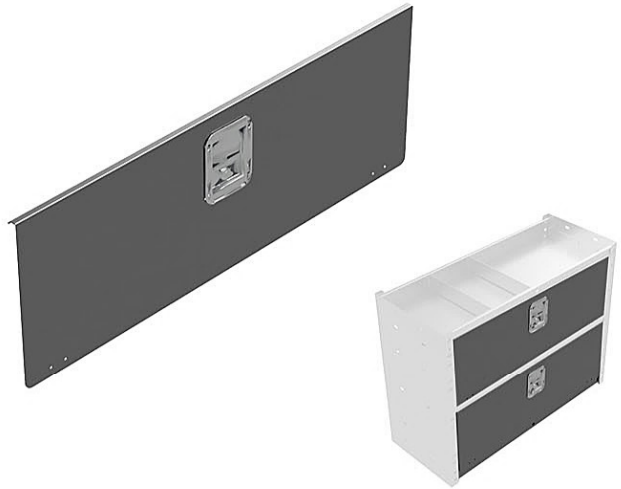

28-28502 - 12''H x 33''L

MUR SÉPARATEUR



20-62003 - 14''H x 13'' DE PROFOND 13''

20-62004 - 14''H x 15'' DE PROFOND 15''

DOSSERET

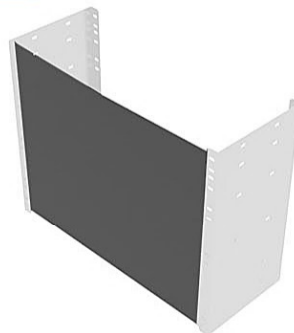

20-61011 - 28''H x 36''L

ENSEMBLE DE BASE - 28''H x 42''Long.



PORTE

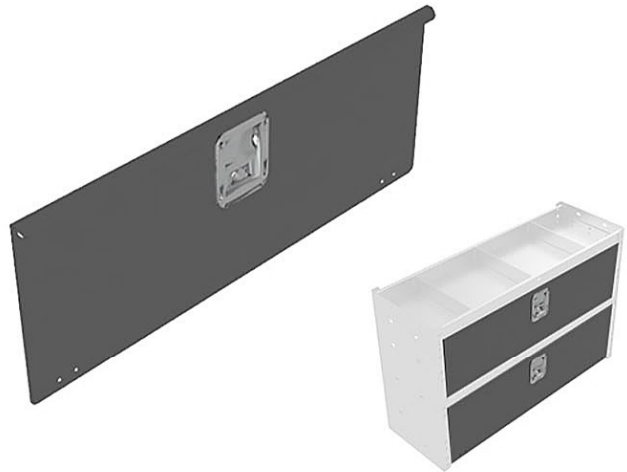

20-21322 - 13'' DE PROFOND 13''

20-21332 - 15'' DE PROFOND 15''

28-28310 - 12''H x 39''L

TABLETTE ADDITIONNELLE - 42''Long.

*INCLUS 3 SÉPARATEURS PAR TABLETTE



28-21023 - 13'' DE PROFOND 13''

28-21033 - 15'' DE PROFOND 15''

MUR SÉPARATEUR



20-62003 - 14''H x 13'' DE PROFOND 13''

20-62004 - 14''H x 15'' DE PROFOND 15''

SÉPARATEUR

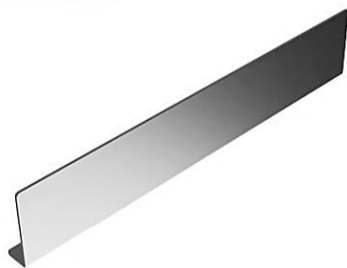

21-41003 - 2 1/2''H x 13'' DE PROFOND 13''

21-41004 - 2 1/2''H x 15'' DE PROFOND 15''

DOSSERET

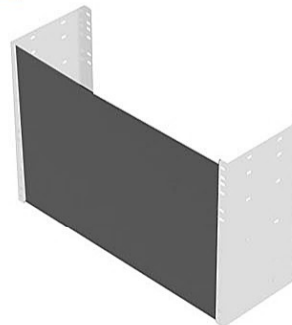

20-61012 - 28''H x 42''L

BAC BLEU

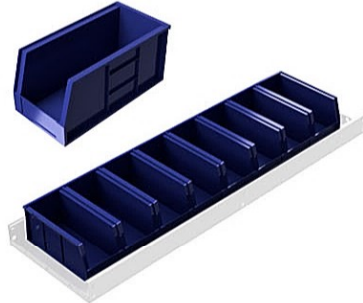

PETIT - 1 à 11 Bacs par tab. 48''
28-33001 - 3''H x 7 1/4'' DE PROFOND 13''

MOYEN - 1 à 8 Bacs par tab. 48''
28-33002 - 5''H x 10 3/4'' DE PROFOND 13''

GRAND - 1 à 5 Bacs par tab. 48''
28-33003 - 7''H x 14 5/8'' DE PROFOND 15''

ENSEMBLE DE BASE - 28''H x 48''Long.



20-21323 - 13'' DE PROFOND 13''

20-21333 - 15'' DE PROFOND 15''

PORTE

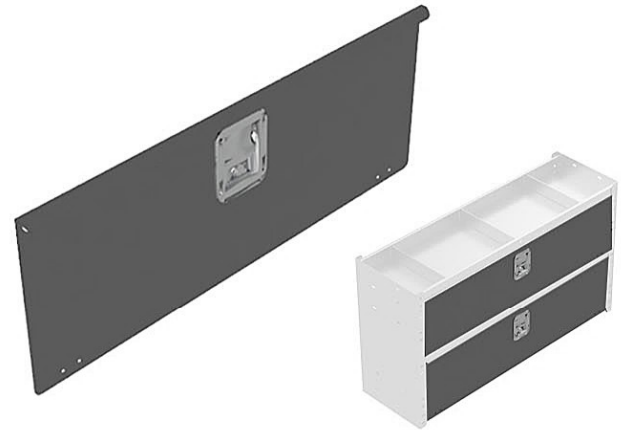

28-28307 - 12''H x 45''L

TABLETTE ADDITIONNELLE - 48''Long.

*INCLUS 3 SÉPARATEURS PAR TABLETTE



28-21023 - 13'' DE PROFOND 13''

28-21033 - 15'' DE PROFOND 15''

MUR SÉPARATEUR



20-62003 - 14''H x 13'' DE PROFOND 13''

20-62004 - 14''H x 15'' DE PROFOND 15''

SÉPARATEUR

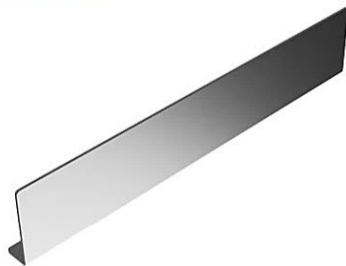

21-41003 - 2 1/2''H x 13'' DE PROFOND 13''

21-41004 - 2 1/2''H x 15'' DE PROFOND 15''

DOSSERET

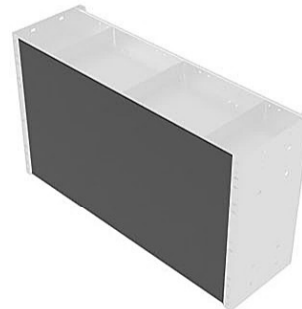

20-61013 - 28''H x 48''L

BAC BLEU



PETIT - 1 à 11 Bacs par tab. 48''
28-33001 - 3''H x 7 1/4'' DE PROFOND 13''

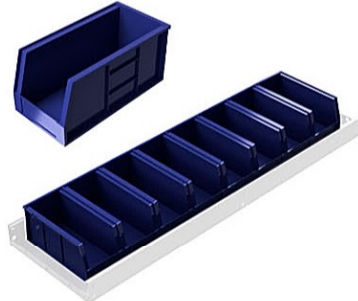

MOYEN - 1 à 8 Bacs par tab. 48''
28-33002 - 5''H x 10 3/4'' DE PROFOND 13''



GRAND - 1 à 5 Bacs par tab. 48''
28-33003 - 7''H x 14 5/8'' DE PROFOND 15''

ENSEMBLE DE BASE - 28''H x 60''Long.



PORTE

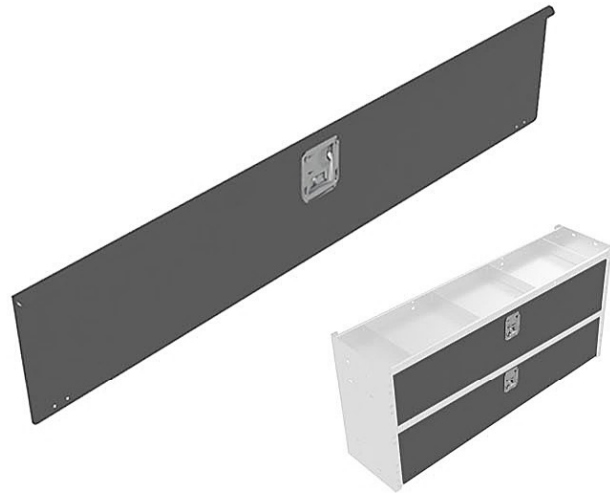

20-21324 - 13'' DE PROFOND 13''

20-21334 - 15'' DE PROFOND 15''

28-28308 - 12''H x 57''L

TABLETTE ADDITIONNELLE - 60''Long.

*INCLUS 4 SÉPARATEURS PAR TABLETTE



28-21024 - 13'' DE PROFOND 13''

28-21034 - 15'' DE PROFOND 15''

MUR SÉPARATEUR

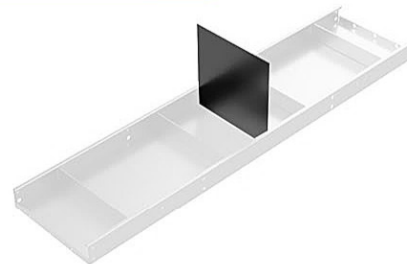

20-62003 - 14''H x 13'' DE PROFOND 13''

20-62004 - 14''H x 15'' DE PROFOND 15''

SÉPARATEUR

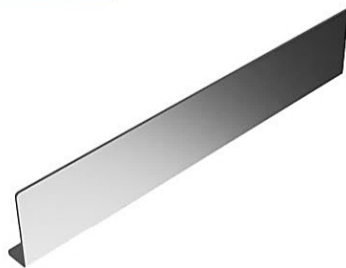

21-41003 - 2 1/2''H x 13'' DE PROFOND 13''

21-41004 - 2 1/2''H x 15'' DE PROFOND 15''

DOSSERET

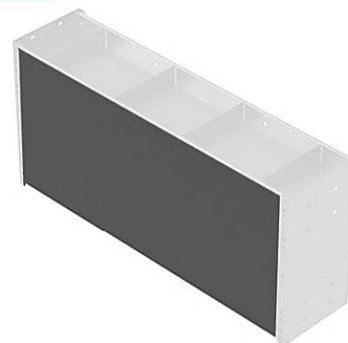

20-61014 - 28''H x 60''L

BAC BLEU



PETIT - 1 à 13 Bacs par tab. 60''
28-33001 - 3''H x 7 1/4'' DE PROFOND 13''

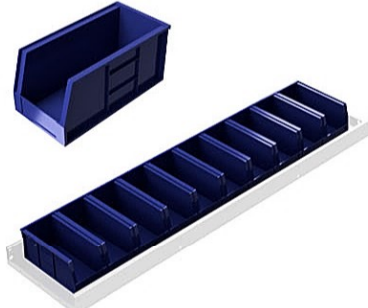

MOYEN - 1 à 10 Bacs par tab. 60''
28-33002 - 5''H x 10 3/4'' DE PROFOND 13''



GRAND - 1 à 6 Bacs par tab. 60''
28-33003 - 7''H x 14 5/8'' DE PROFOND 15''

ENSEMBLE DE BASE - 28''H x 72''Long.

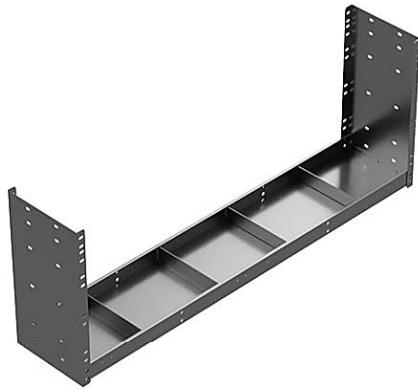

20-21325 - 13'' DE PROFOND 13''

20-21335 - 15'' DE PROFOND 15''

PORTE

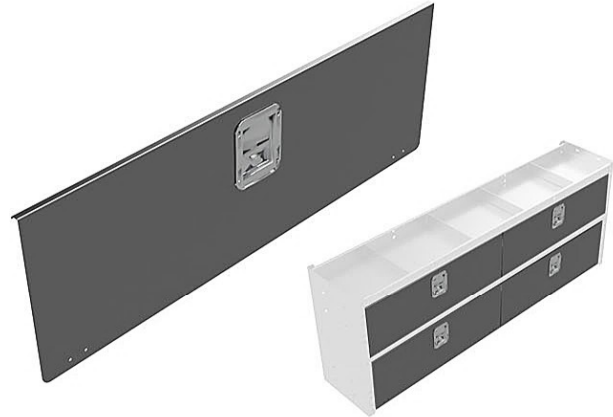

28-28306 - 12''H x 34 3/8''L

TABLETTE ADDITIONNELLE - 72''Long.

*INCLUS 5 SÉPARATEURS PAR TABLETTE



28-21027 - 13'' DE PROFOND 13''

28-21037 - 15'' DE PROFOND 15''

MUR SÉPARATEUR

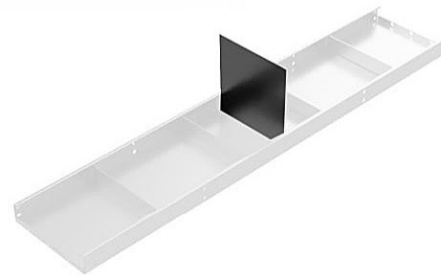

20-62003 - 14''H x 13'' DE PROFOND 13''

20-62004 - 14''H x 15'' DE PROFOND 15''

SÉPARATEUR

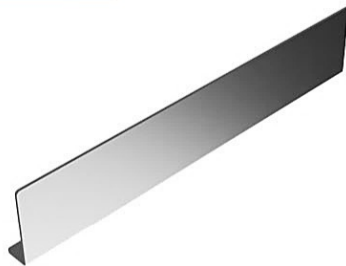

21-41003 - 2 1/2''H x 13'' DE PROFOND 13''

21-41004 - 2 1/2''H x 15'' DE PROFOND 15''

DOSSERET



20-61015 - 28''H x 72''L

BAC BLEU

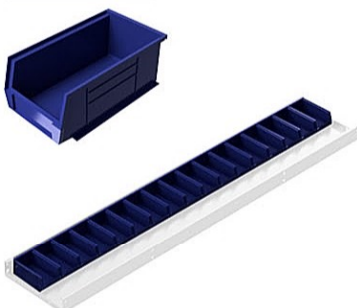

PETIT - 1 à 16 Bacs par tab. 72''
28-33001 - 3''H x 7 1/4'' DE PROFOND 13''

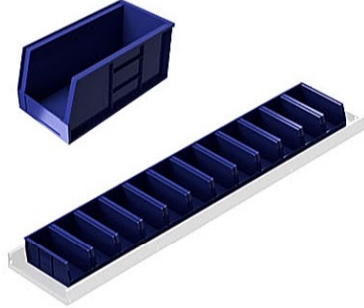

MOYEN - 1 à 12 Bacs par tab. 72''
28-33002 - 5''H x 10 3/4'' DE PROFOND 13''



GRAND - 1 à 8 Bacs par tab. 72''
28-33003 - 7''H x 14 5/8'' DE PROFOND 15''

ENSEMBLE DE BASE - 28''H x 84''Long.

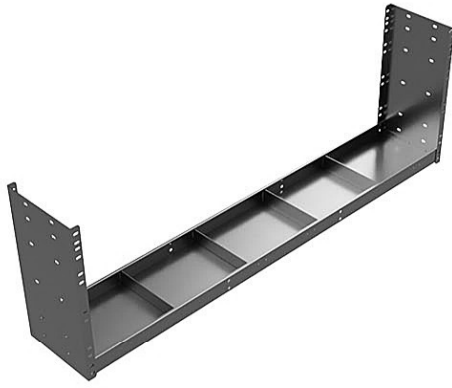

PORTE

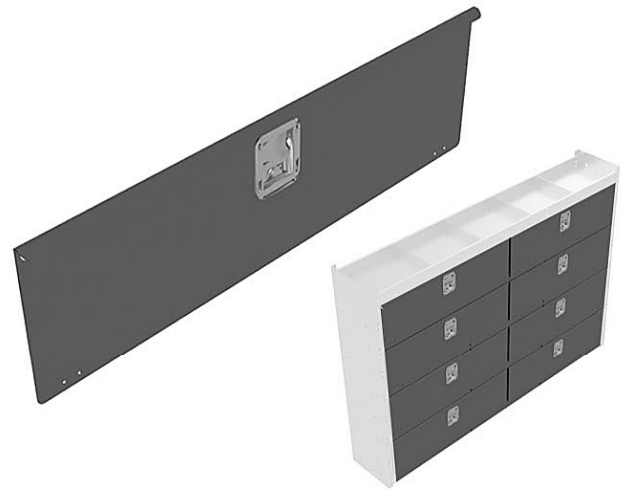

20-21326 - 13'' DE PROFOND 13''

20-21336 - 15'' DE PROFOND 15''

28-28309 - 12''H x 40''L

TABLETTE ADDITIONNELLE - 84''Long.

*INCLUS 5 SÉPARATEURS PAR TABLETTE

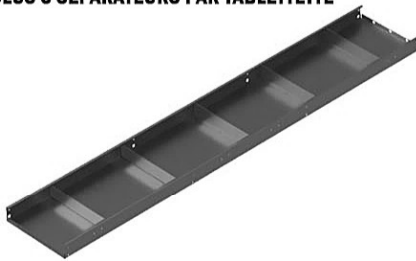

28-21026 - 13'' DE PROFOND 13''

28-21036 - 15'' DE PROFOND 15''

MUR SÉPARATEUR

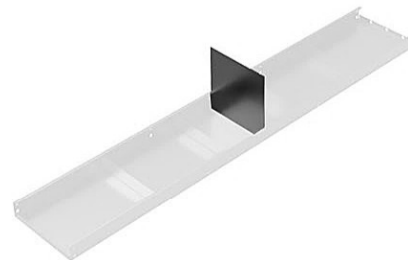

20-62003 - 14''H x 13'' DE PROFOND 13''

20-62004 - 14''H x 15'' DE PROFOND 15''

SÉPARATEUR

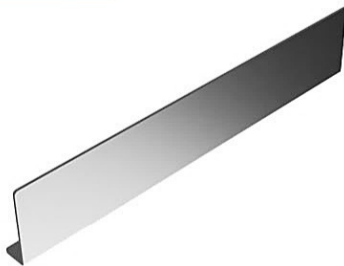

21-41003 - 2 1/2''H x 13'' DE PROFOND 13''

21-41004 - 2 1/2''H x 15'' DE PROFOND 15''

DOSSERET

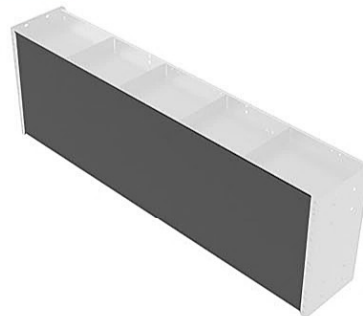

20-61016 - 28''H x 84''L

BAC BLEU

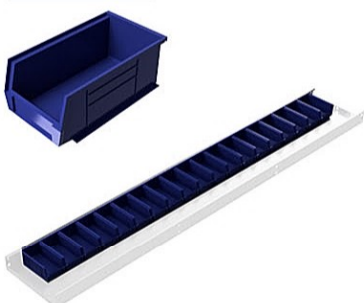

PETIT - 1 à 19 Bacs par tab. 84''
28-33001 - 3''H x 7 1/4'' DE PROFOND 13''

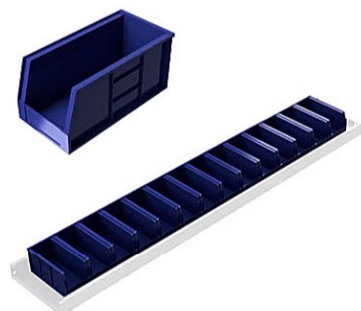

MOYEN - 1 à 14 Bacs par tab. 84''
28-33002 - 5''H x 10 3/4'' DE PROFOND 13''

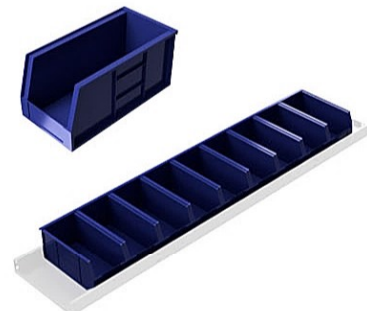

GRAND - 1 à 9 Bacs par tab. 84''
28-33003 - 7''H x 14 5/8'' DE PROFOND 15''

ENSEMBLE DE BASE - 28''H x 92''Long.

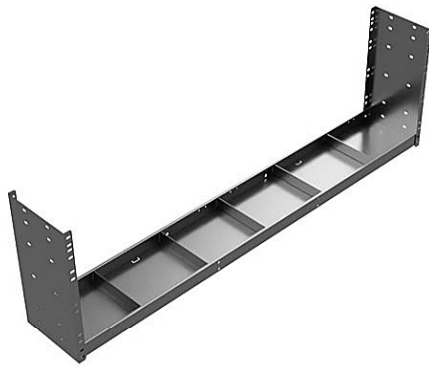

PORTE

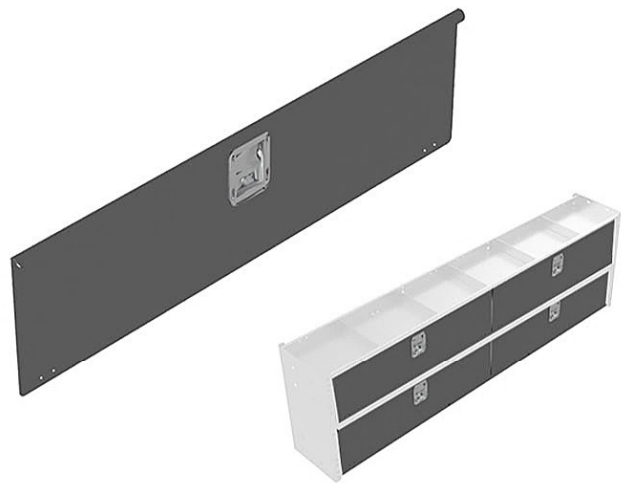

20-21327 - 13'' DE PROFOND 13''

20-21337 - 15'' DE PROFOND 15''

28-28310 - 12''H x 44'' L

TABLETTE ADDITIONNELLE - 92''Long.

* INCLUS 6 SÉPARATEURS PAR TABLETTE



28-21027 - 13'' DE PROFOND 13''

28-21037 - 15'' DE PROFOND 15''

MUR SÉPARATEUR

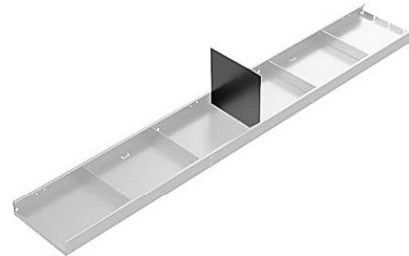

20-62003 - 14''H x 13'' DE PROFOND 13''

20-62004 - 14''H x 15'' DE PROFOND 15''

SÉPARATEUR

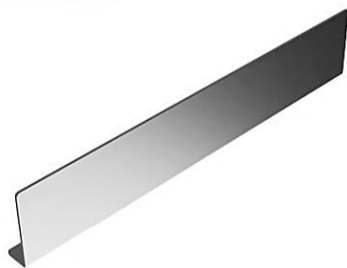

21-41003 - 2 1/2''H x 13'' DE PROFOND 13''

21-41004 - 2 1/2''H x 15'' DE PROFOND 15''

DOSSERET

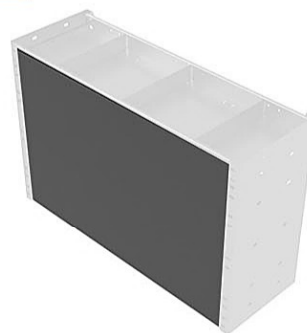

20-61017 - 28''H x 92''L

BAC BLEU

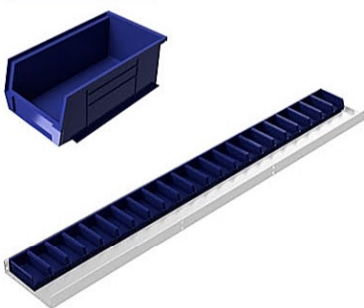

PETIT - 1 à 22 Bacs par tab. 92''
28-33001 - 3''H x 7 1/4'' DE PROFOND 13''

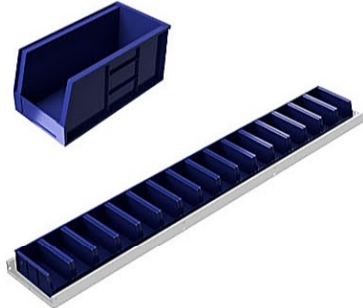

MOYEN - 1 à 16 Bacs par tab. 92''
28-33002 - 5''H x 10 3/4'' DE PROFOND 13''

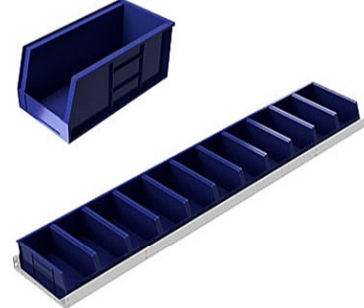

GRAND - 1 à 11 Bacs par tab. 92''
28-33003 - 7''H x 14 5/8'' DE PROFOND 15''